



RADIO & Television RETAILING

Including Radio and Television Today

ELECTRONIC-PARTS CONFERENCE NUMBER

Post-war Home Appliance Selling • Radio Jobber Markets and Problems

OCTOBER 1944

Original Circuit

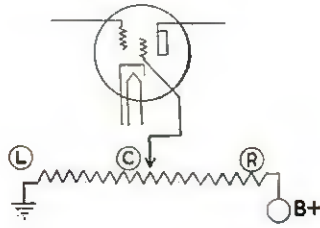

Suggestion No. 1 for 10,000 ohm wire-wound original control.
No change necessary.

Suggestion No. 2 where original control is under 10,000 ohms.

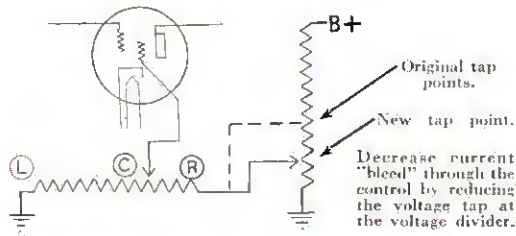

Suggestion No. 3 where original control is over 10,000 ohms.

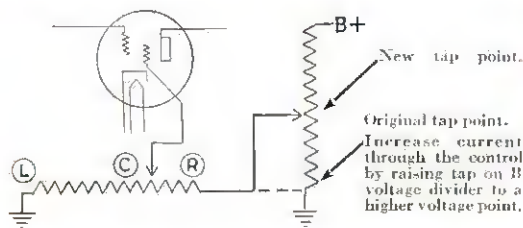

Suggestion No. 4 Change circuit to Antenna Bias. Wire in screen circuit permanently at correct voltage.

To Help You Replace Volume Controls in Screen Circuits with the 10,000 Ohm Linear Units

In screen voltage control circuits, the action of the control is similar in most respects to the action obtained by controlling the bias of the tube. The mutual conductance (plate current to grid voltage trans-conductance) of the tube varies with the screen voltage.

When you must make a replacement and are unable to match the value and taper of the original control, try whichever of the four suggestions listed here fits your particular job. The suggestions are purposely general—to show the possibilities of wartime radio servicing. In cases where you feel you require additional assistance, send your problems to Mallory Technical Information Service. We'll be glad to help you find solutions.

P. R. MALLORY & CO., Inc.
INDIANAPOLIS 6 INDIANA



Buy More War Bonds

Mallory Helps for the Radio Service Engineer

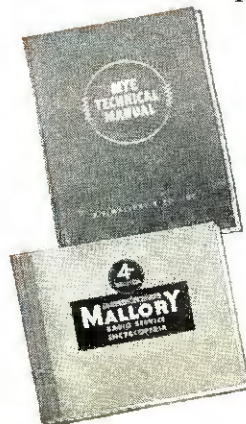

MYE TECHNICAL MANUAL.
—108 pages of complete data on capacitors, noise suppression, receiving tubes, loud speakers, vibrators, phono-radios, automatic tuning and other valuable information. Available from your Mallory distributor... Price, \$2.00.

4TH EDITION RADIO SERVICE ENCYCLOPEDIA : : :
Complete information on repairing any make or model of receiver. Circuit references, original part numbers and recommended replacements. Available from your Mallory distributor... Price, 95 cents.

P. R. MALLORY & CO. Inc.

MALLORY

Approved Precision Products

It's a postwar Promise ... from

Admiral

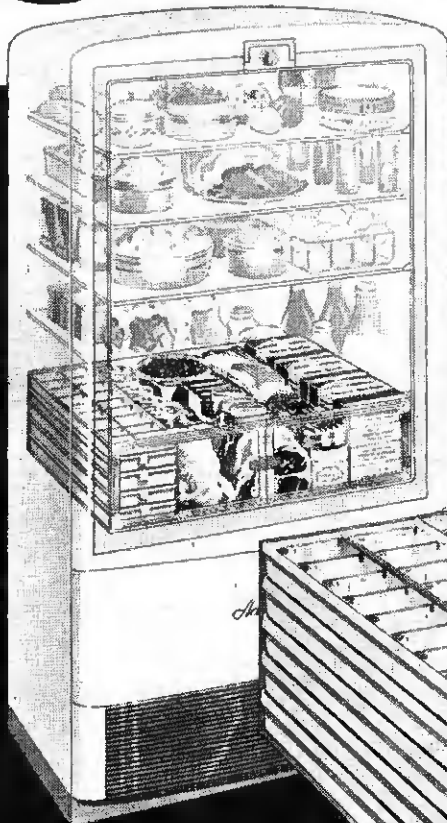

**A refrigerator
with a built-in
HOME FREEZER**

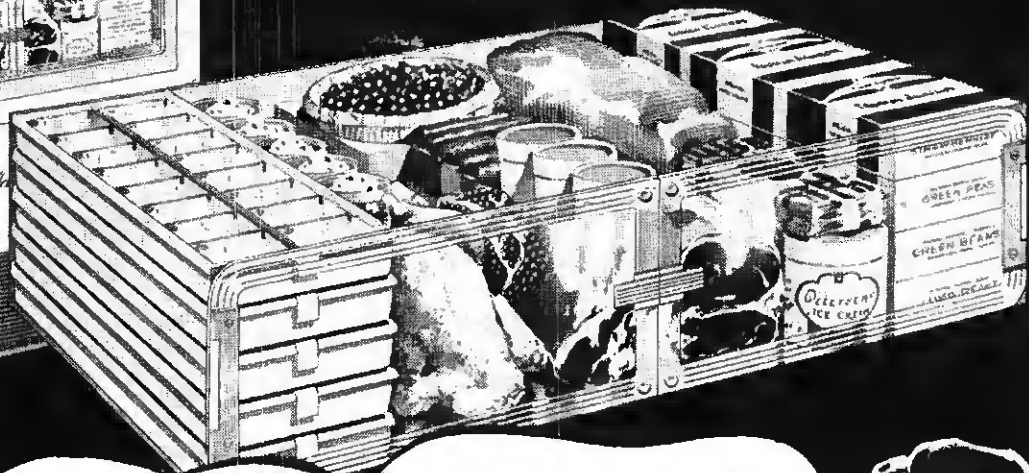

*Room to store
2 bushels of
frozen food!*

*BR-R-R-R It's cold!
22 degrees
below freezing!*



TUNE IN CBS Sundays for
Admiral "World News Today"

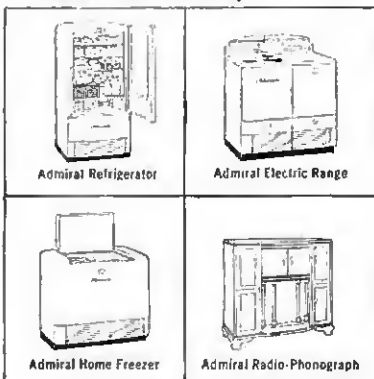

Admiral Refrigerator

Admiral Electric Range

Admiral Home Freezer

Admiral Radio-Phonograph

Perhaps you have a refrigerator that wastes meats for months or quick freezers unable to enjoy a bushel of ice in time tasks and a freezer in the house have all these Sterilamp — u kill bacteria No Defrosting — a

MEMO—This story of the Admiral two-temperature refrigerator is currently running in national magazines and newspapers with a total circulation of 32,784,314... There's a live Admiral distributor in your territory. Ask him about the profit possibilities for you in Admiral radios, refrigerators, home freezers and electric ranges. P.S. Let him tell you about Admiral's Flex-O-Plan store remodeling ideas, too.

Get the facts and you'll GET ABOARD WITH ADMIRAL

Admiral Corporation

CHICAGO 47, ILLINOIS

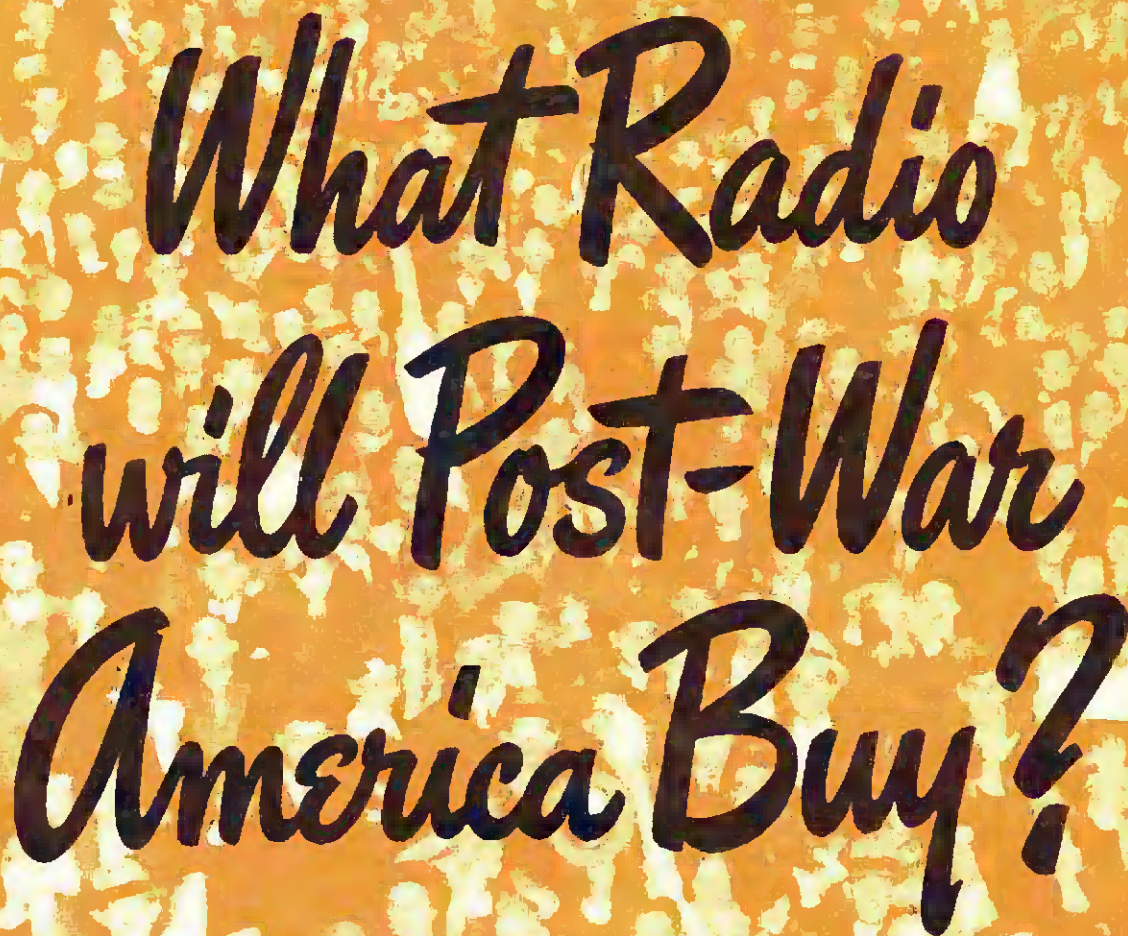

What Radio will Post-War America Buy?

The statements in this advertisement are based on a survey made by the publishers of a leading monthly national magazine (name on request). It confirms the findings of a number of similar impartial surveys made by various publications and fact-finding organizations throughout the country.

LOOKING TO THE DAY when the manufacture and sale of civilian merchandise will be resumed, a number of publications and fact-finding organizations have undertaken to find out what the public intends to buy. That's important information for you... information on which you can base your plans for the future.

One such survey was recently made and published by a leading national magazine. It showed that:

- ➔ **65% of its readers intend to buy a new radio or phonograph after the war...**
- ➔ **More than twice as many intend to buy a Philco as any other brand...**
- ➔ **There will be as many Philco buyers as the next three makes combined...**
- ➔ **Yes, overwhelmingly... America's post-war radio will be a Philco!**

These are potent facts for every radio dealer today. Big opportunities lie ahead

in the radio field. And the biggest profits await those who prepare themselves to sell what the public wants to buy.

Of course, this survey reveals other interesting facts about Philco *leadership*. By far the greatest number of radios in homes today, consoles as well as table models, are Philco. And among Philco owners, as compared with owners of other makes, *by far the largest percentage intend to buy another Philco after the war*. That means loyal, satisfied users... the strongest kind of leadership in public demand. And in this connection, remember... America has bought over 17 million Philco radios!

One final fact. Philco understands the meaning and the obligation revealed in these surveys. Philco engineering before the war *earned* that leadership. Philco engineering... yes, and Philco merchandising, advertising and promotion... will be prepared to *continue* that leadership when Victory is won!



Overwhelmingly, it's a
PHILCO

Products of "MERIT"

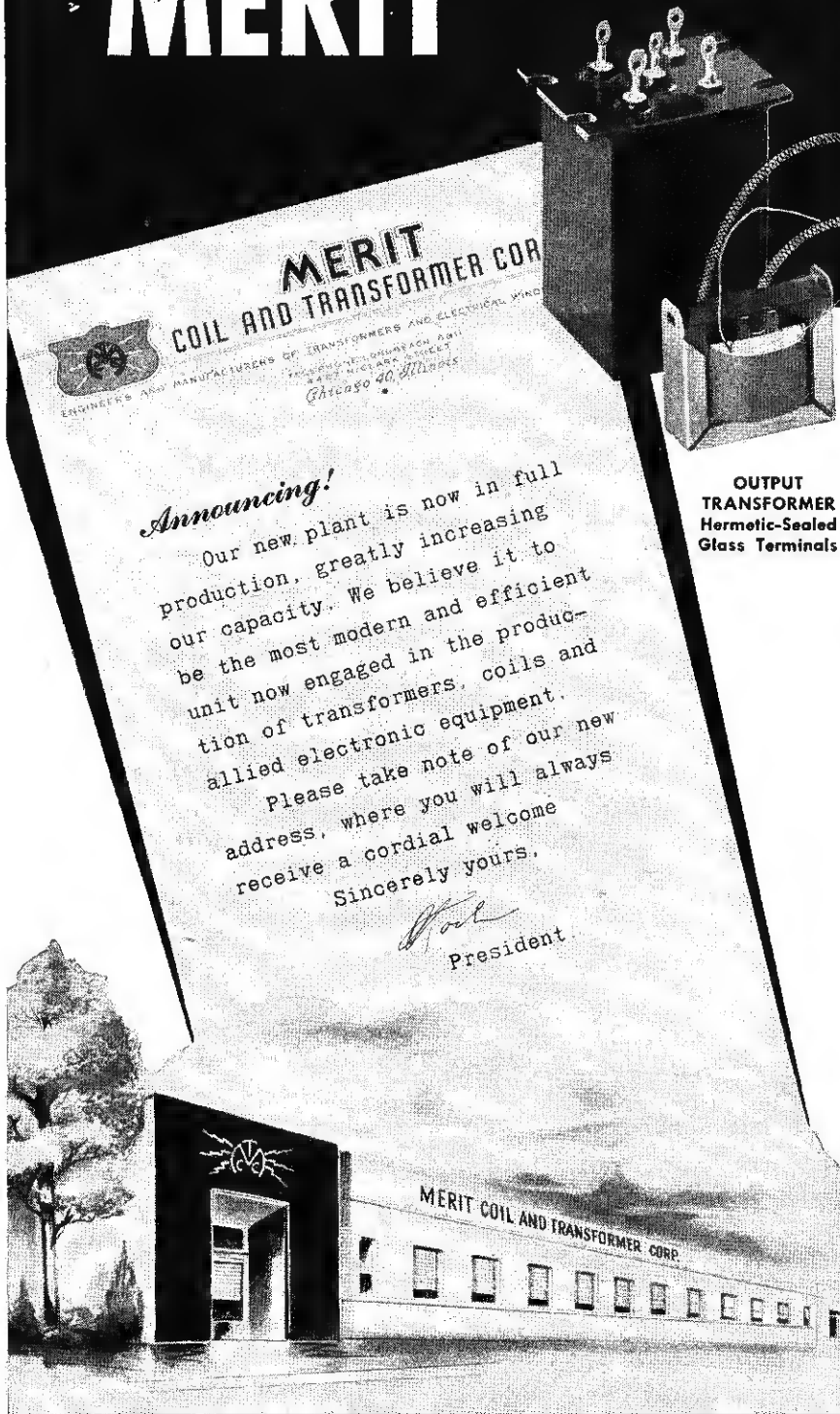

Announcing!

Our new plant is now in full production. Greatly increasing our capacity. We believe it to be the most modern and efficient unit now engaged in the production of transformers, coils and allied electronic equipment.

Please take note of our new address, where you will always receive a cordial welcome

Sincerely yours,
W. H. Caldwell
President

OUTPUT TRANSFORMER
Hermetic-Sealed
Glass Terminals

MERIT COIL & TRANSFORMER CORP.
4427 North Clark St. CHICAGO 40, ILL.

RADIO Television RETAILING

MEMBER AUDIT BUREAU OF CIRCULATIONS

OCTOBER, 1944

COVER—President Geo. D. Barbey of NEDA (see page 88) talks parts inventory with one of Reading, Pa.'s radio servicers, Paul Reed (see page 82)

Page

- 31 Job Ahead for Radio Jobbers
- 32 Radio and Appliances Today
- 34 Looking Ahead to Radio-Appliance Sales
- 36 School for Radio Experts
- 38 Pep Up Your Storefront
- 40 Radiomen Active Across USA
- 42 Postwar Distribution Quiz
- 44 Centralized Sound System
- 46 Records Will Sell Appliances
- 48 Sales in Children's Discs
- 50 Jobbers Super-Market
- 54 Recording Specialists
- 58 Wholesaling on Wheels
- 60 Appliance Past and Future
- 66 Power Amplifier Facts
- 76 Sell Your Service
- 80 Distributor Doings
- 82 Electronic Expert
- 86 Sells While He Services
- 90 Television Talk
- 110 What's New

RADIO & Television RETAILING, October, 1944, Vol. 29, No. 10. 25 cents a copy. Published monthly by Caldwell-Clements, Inc., 480 Lexington Ave., New York 17, N. Y. M. Clements, president; Orestes H. Caldwell, treasurer. Subscription rates United States and Latin American countries, \$1.00 for one year, \$2.00 for three years. Canada \$1.50 for one year, \$3.00 for three years. All other countries \$2.00 for one year, \$4.00 for three years. Printed in U.S.A. Re-entered as second class matter April 21, 1944, at the Post Office at New York, N. Y., under the act of March 3, 1879. Member of Audit Bureau of Circulations. Copyright by Caldwell-Clements, Inc., 1944.

ORESTES H. CALDWELL

Editor

M. CLEMENTS

Publisher

H. L. M. Capron, Merchandising Editor
William E. Moulie, Technical Editor
Helen Thurman, Associate Editor
John L. Stoutenburgh, Associate Editor
Charles F. Dreyer, Art Director

E. T. Bennett	Hope Bedard
M. H. Newton	J. A. Samborn
B. V. Spinetta	O. H. Sutter
N. McAllister	W. W. Swigert
J. E. Cochran	L. D. Chesson

Lee Robinson, Sales Manager

R. Y. Fitzpatrick, Western Manager
Chicago, 201 N. Wells St.
Telephone RANdolph 9225

Editorial and Executive Offices

Telephone PLaza 3-1340
480 Lexington Avenue
New York

If she
likes it
.....
You're
all set

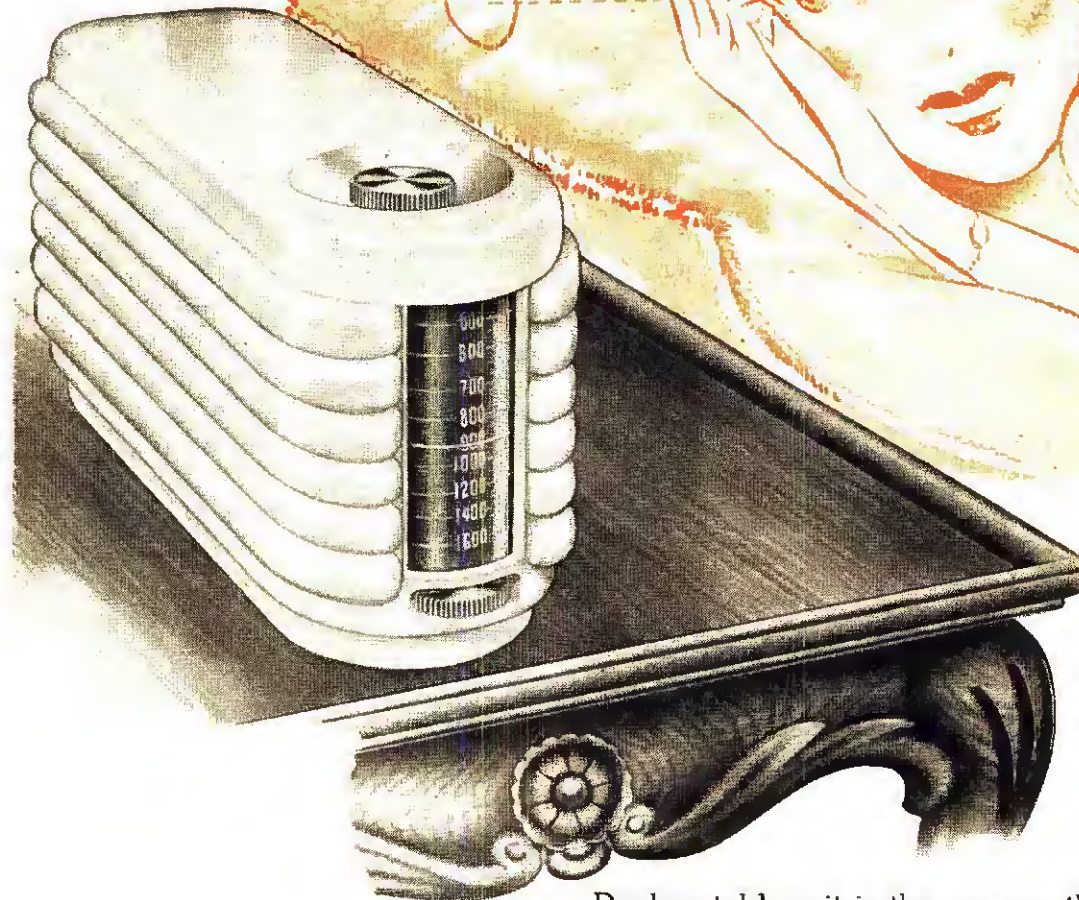

Dealers told us it is the woman that usually buys the "second set"—the extra radio for the bedroom or kitchen, etc. Dealers told us that Eye Appeal is the great selling point—the one that "closes" these women buyers.

MECK Radios introduce startling new cabinets created by America's foremost designers. Every one will help you get a bigger share of this pent-up market.

The Line Dealers Designed

By checking service records of hundreds of dealers we have learned where to put the "EXTRA QUALITY". Our own engineering plus the resources of the great engineering laboratories of RCA, Western Electric and Hazeltine, thru license agreements is your guarantee of trouble-free performance.

For a more complete story of a great post-war selling opportunity write today.



MECK

RADIOS • PHONOGRAPHS

★ ★ ★

PLYMOUTH • INDIANA

DISTRIBUTED NATIONALLY THRU RADIO EQUIPMENT JOBBERS

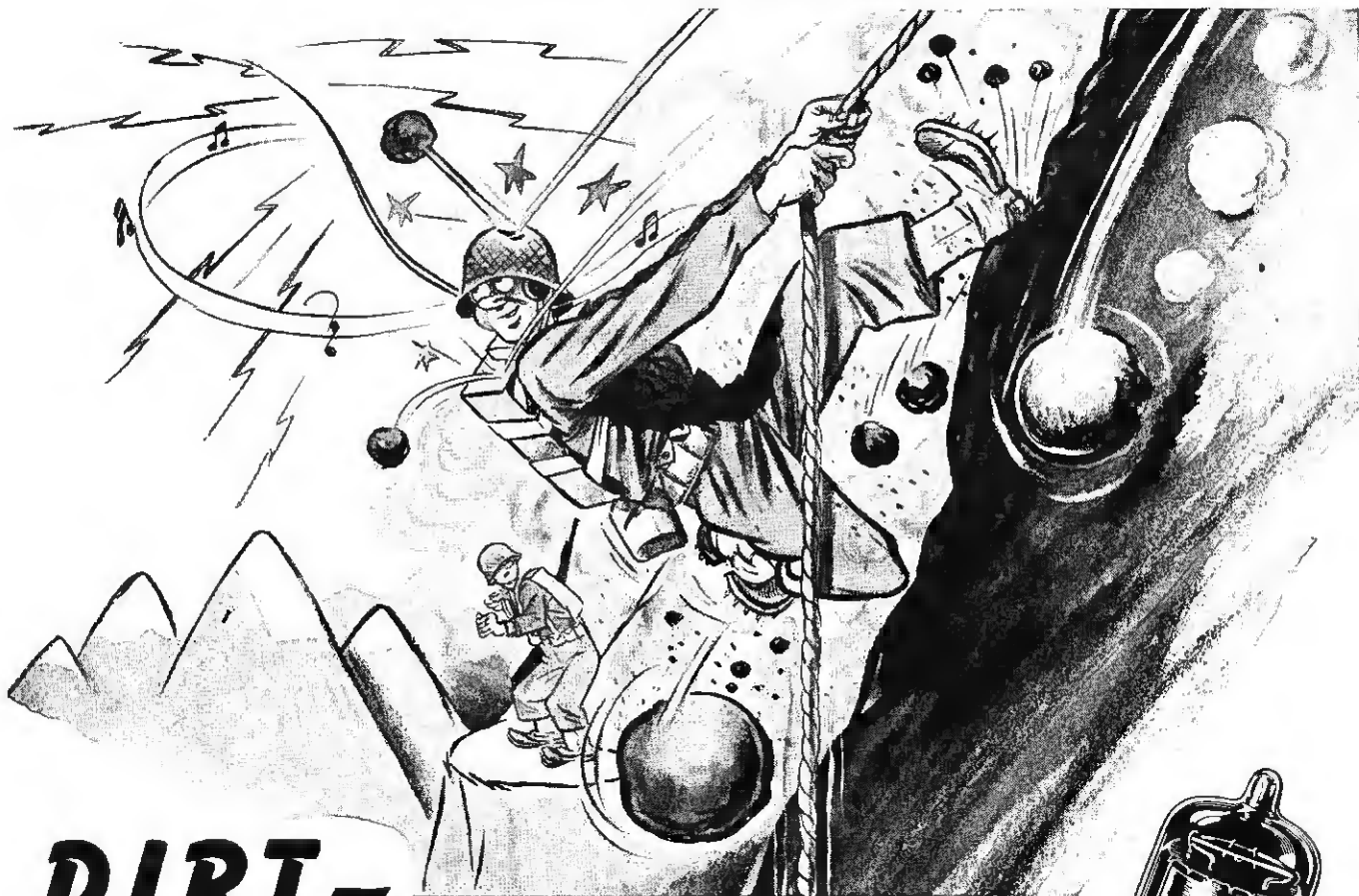

DIRT-

INSIDE ELECTRONIC TUBES CAN CAUSE TROUBLE TOO

Foreign matter within an Electronic Tube was always a hazard. Now, with the tendency toward miniature tubes and smaller parts with less distances between them, even a tiny thread of lint free in the glass enclosure can prove very damaging.

The TUNG-SOL regular procedure of washing and baking all mounts and glass enclosures just before sealing has proven a more than worth while precaution. It not only removes all dirt and dust and lint from component parts but at the same time removes any deposit of harmful salts that might poison the emission

of electrons from the filament.

This final cleaning is just one of the innumerable practices instituted by TUNG-SOL research and development engineers, who have given TUNG-SOL Electronic Tubes their ruggedness, long life, efficiency and uniformity. These characteristics are important to jobbers who sell electronic devices and dealers who service them. The line of TUNG-SOL Tubes has been expanded. Today there is a tube for every purpose and every tube is efficient and dependable.

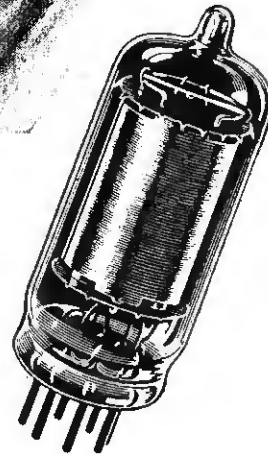

EVERY DAY IS WASH DAY...

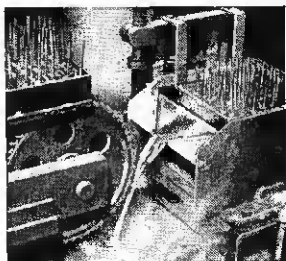

A continuous flow of hot water is introduced through the bottom of the washing tank and is discharged out the top floating the lint and foreign matter out with it. This prevents contamination of water. After washing, both mounts and enclosures travel through a high temperature oven, thoroughly clean and ready for exhaust.

TUNG-SOL

vibration-tested

ELECTRONIC TUBES



TUNG-SOL LAMP WORKS INC., NEWARK 4, NEW JERSEY

ALSO MANUFACTURERS OF MINIATURE INCANDESCENT LAMPS, ALL-GLASS SEALED BEAM HEADLIGHT LAMPS AND CURRENT INTERMITTORS
RADIO & Television RETAILING • October, 1944

FARNSWORTH . . .

THE NAME CUSTOMERS WILL LOOK FOR IN

TELEVISION
RADIO
PHONOGRAPHS

When your business comes back with a rush, the Farnsworth name is going to bulk larger than ever in customers' minds.

"Farnsworth — pioneer in television." "Farnsworth — famous for record-changers and phonograph tone." "Farnsworth — outstanding radios with the most distinctive line of cabinets." That's what they know — that's what will make selling the great new Farnsworth products easy.

Advertising messages like these have continued a program started before the war. They have been aimed toward maintaining and increasing the acceptance and reputation of Farnsworth products. Thus a foundation has been established for one of the most valuable protective franchises in the post-war era.

The very finest quality in every price range — that's Farnsworth's post-war program. It's a program that can make money for you!

FARNSWORTH

Television · Radio · Phonographs

Farnsworth Television & Radio Corporation, Ft. Wayne 1, Ind. • Farnsworth Radio and Television Transmitters and Receivers; Aircraft Radio Equipment; Farnsworth Television Tubes; the Farnsworth Phonograph-Radio; the Capehart, the Capehart-Panamuse

ARVIN

Radios

FOR FAMILY SALES APPEAL

Upstairs...
DOWNSTAIRS

Dad has a Ball Game
 ● When he takes a nap in his room, Dad listens to his ball game on his Arvin Radio.

Mother hears the Opera
 ● When she cooks in her kitchen, Mother listens to all news on her Arvin Radio.

Sister has a Swing Band
 ● Whether she works in a room, Sister listens to a big swing band on her Arvin Radio.

Junior's way out West
 ● While he builds model planes, Junior listens to a Western Thriller on his Arvin Radio.

ARVIN Radios
 ALL THROUGH THE HOUSE!
 When The War Is Won

★ Dad wants baseball while Mother wants opera. Sister wants a swing band while Junior wants a Western Thriller. That's a typical Saturday afternoon in millions of homes—where everyone in the family wants something different on the radio, all at the same time. To keep everybody happy, several radios are needed.

With Arvin Radios upstairs, downstairs and all through the house, the family problem is solved. The convenience and individual pleasure are without measure. The cost is modest.

But that's a peacetime picture for most homes. Only a few families love all the radios they'd like to have now and can't get more. We're helping to hurry better days along by making radios and electronic equipment for war now—working with all the new developments that will make the coming Arvin Radios even better.

You help to bring the new Arvin Radios to you sooner with every war bond you buy. Keep on buying more war bonds.

ARVIN IS THE NAME on Peacetime Products of NOBLITT SPARKS INDUSTRIES, INC., COLUMBUS, INDIANA
 War Bonds for Radios • Gift Sets • Record Players • News and Sport Radios • Music • Drama Sets • Station Model Furniture • Other Home Equipment
 Featured in the main and special ad for our Columbus office

When radio production starts again, a fine family of radios will come to dealers under the well-known Arvin name. And this line will have family sales appeal. Why? Because the range of models and prices will be so appealing that many families will buy several Arvins—for upstairs, downstairs, all through the house and outdoors, too.

The Arvin line will include a splendid group of floor models—with automatic record changers and F.M.—small and larger table sets for every place and person, some with record players and automatic changers. There'll be several portables—from coatpocket to hand bag sizes—battery sets for cabins and rural homes, too.

The line will be long enough to cover a wide range of practical family needs and desires—but short enough that dealers can display and sell all Arvin models with good turnover and excellent profits.

NOBLITT-SPARKS INDUSTRIES, INC. • COLUMBUS, INDIANA



Awarded to the men and women of four of our Columbus plants

At left is a miniature reproduction of a full page which recently appeared in leading national magazines such as Life and The Saturday Evening Post—pre-selling the idea of more Arvin Radios in more family homes.

LET'S KEEP ON BOOSTING WAR BOND BUYING

ALLEN H. GARDNER, President

Colonial Radio Corp. . . .

"The public knows only part of the splendid job electronic engineers have done during the war, and of the marvelous accomplishments that have been made in radio communications, because of the extremely secret nature of most of the developments. One of the results which can be mentioned now is the . . .



"TREMENDOUS INCREASE IN NEW USES FOR MODERN, VERSATILE VIBRATOR POWER SUPPLIES"

Yes, Mr. Gardner, many fields, after the war, will find E-L Vibrator Power Supplies the key to a host of new improvements in their products and services. The transit industry, radio, aviation, railroad, marine, electrical and electronic are just a few of the fields in which E-L equipment will do many important jobs. . . . The most significant new E-L development is the perfection of an electrical current division circuit between vibrator contacts. This has made possible an enormous increase in output capacity, to as much as 1500 watts at present!

For the transit field, Electronic Laboratories offer four patented current conversion systems for fluorescent lighting in all types of vehicles. These systems will operate any type or size fluorescent lamp, either hot or cold cathode, as well as any number of lamps.

E-L is ready now to bring you the benefits of its tremendous wartime experience for two-way radio in planes, trains, transcontinental busses, boats and other fields. . . . Multiple input and output units are available. Vibrator Power Supplies may be designed to supply any needed wave form. They are efficient and long-lived and economy is assured with the minimum of maintenance. E-L design engineering service will design a Vibrator Power Supply to meet specific requirements in size, weight and voltage.

E-L STANDARD POWER SUPPLY MODEL 619

This is a typical unit for mobile or portable applications with such equipment as 5 or 10 meter shortwave rigs. Model 619 allows you to operate from regular 115 volt AC power line and then switch easily to a 6 volt DC battery. Characteristics: Input voltage, 115 volts (60 cycle AC and 6 volts DC; Output voltage, 6.3 volts AC at 100 ma. and 300 volts DC at 100 ma.; Output power, 55 watts maximum.

Dimensions: 9 1/2 x 5 1/2 x 6 inches. Weight: 1.85 pounds

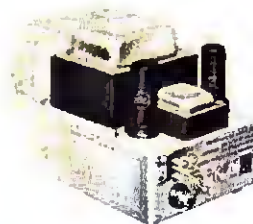

Write for further information of this and other power supply models with different inputs and outputs for a wide range of uses.

Electronic



LABORATORIES INC.

INDIANAPOLIS

VIBRATOR POWER SUPPLIES FOR LIGHTING, COMMUNICATIONS, AND ELECTRIC MOTOR OPERATION • ELECTRIC, ELECTRONIC AND OTHER EQUIPMENT

MEMO TO *Purchasing Dept.*

In our postwar radio sets, recommend you buy Solar SealDite Tubular Capacitors - they're the best we've ever tested - the only way - molded units - superior protection against moisture.

E.M.

**ENGINEERING
SPECIFY
SOLAR
DEPARTMENT**

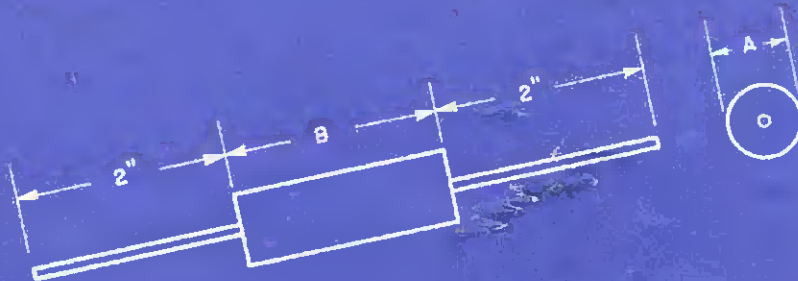

**LEADING MANUFACTURERS
EVERYWHERE**

ART NO.	SOLAR PART NO.	CAP'Y MFD.	WKG. VOLTS	DIMENSIONS		DRAWN	DATE
				"A"	"B"		
9A40-1	S-0211	.001	600	3/8	1-3/16	<i>E.U.H.</i>	8/15/44
9A40-2	S-0215	.005	600	3/8	1-3/16	<i>M.</i>	49A40
49A40-3	S-0221	.01	600	7/16	1-5/8	<i>J.C.</i>	ISSUE
49A40-4	S-0224	.02	600	7/16	1-5/8		
49A40-5	S-0230	.05	600	9/16	2-1/8		
49A40-6	S-0240	.1	600	9/16	2-1/8		

Prominent engineers consistently show their preference for Solar Capacitors. Solar pledges continued production of superior quality capacitors to merit that preference. Solar Manufacturing Corporation, 285 Madison Avenue, New York 17, N. Y.



**CAPACITORS &
ELIM-O-STATS**

When the Order Comes to

"Cease Firing"!



Previous Wars

In 1918, slow communications delayed the transmission of "cease firing" orders resulting in countless casualties after official surrender.

Present War

This time! . . . Thanks to modern radio communications fighting will be stopped instantly in every theatre of war following surrender.



Sentinel

In World War II coordination of armed forces, to fire together for Victory, and to *cease firing* when Victory is won, has been attained through radio—and Sentinel has played a prominent part in the development of this modern miracle.

The vital wartime equipment that Sentinel is creating and producing is helping to bring swiftly the moment of surrender.

Then, Sentinel will continue forward, conditioned by wartime experiences, to produce radio and electronic equipment that will bring volume sales to Sentinel dealers.

SENTINEL RADIO CORPORATION
2020 Ridge Avenue, Evanston, Illinois

Quality
Radio Since
1920

NORGE Offers You the **PROFITS** and **EXTRA SALES** of a **Complete Line of Major** **Home Appliances**

EVERY SUCCESSFUL DEALER KNOWS —

One outstanding appliance will sell others of the same brand. A family pleased with a Norge Rollator refrigerator is a ready prospect for a Norge range. It's basic appliance selling!

And that's why Norge dealers will enjoy *profits* from *extra sales*. Norge will give them a *complete* line of brilliant major home appliances under one famous name. And in addition to the quality line of Rollator Refrigerators, Gas and Electric Ranges, Washers and Home Heaters, Norge will offer new pace-setters in postwar profit-makers for Norge dealers to present to America's waiting homemakers . . . all the opportunities for a great future.

Norge means new products for waiting home owners to buy. Norge means new products for far-thinking dealers' profit. Norge means a *successful future* for Norge dealers!

Norge Division, Borg-Warner Corporation
Detroit 26, Michigan

A BORG-WARNER INDUSTRY

BETTER PRODUCTS FOR A BETTER WORLD

SEE

NORGE
BEFORE YOU BUY

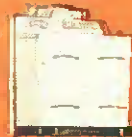

"...for outstanding
production of
war material."

ONE FAMOUS NAME—

*...All Major
Appliances*



*You'll have
a great future
with*

NORGE

**RAY-O-VAC
LEAKPROOF
BATTERIES**
are bound
to be post-
war leaders

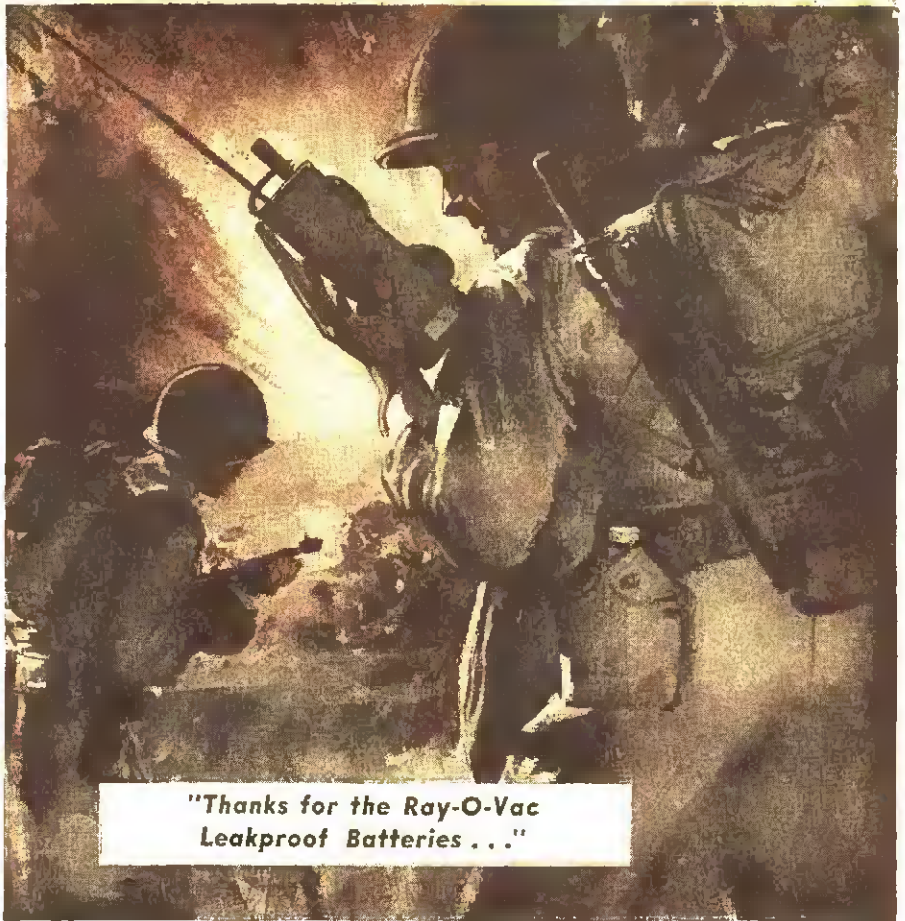

"Thanks for the Ray-O-Vac
Leakproof Batteries . . ."

It's the battery that STAYS FRESH because its sealed-in-steel construction prevents power leakage. It is guaranteed not to harm by swelling or corrosion. Millions of men are learning the reliability of Ray-O-Vac LEAKPROOFS under life-and-death conditions. It's the cell they're going to insist upon when they return from the fighting fronts.

Sorry, but no more LEAKPROOFS till after Victory

Those Ray-O-Vac LEAKPROOF Batteries that your customers want are all going to our fighting men. They furnish the heartbeat of communication systems, handie-talkies, bazookas, flashlights and other instruments of war.



BUY WAR BONDS



BUY WAR STAMPS

Guaranteed
BATTERIES



FLASHLIGHT • TELEPHONE • LANTERN • HEARING AID • RADIO • IGNITION • MULTIPLE

*This is only
the beginning...*

Garod, true to pre-war form when we were first with many radio advancements, charts a peacetime promotional course headed straight for successful consumer acceptance from the very beginning.

Big names will be co-starred with GAROD quality sets before an audience of millions of readers of national magazines.

But, this is only the beginning...

Arrangements are now being made for an ENTIRELY DIFFERENT type of RADIO PROGRAM on a hook-up of leading stations.

Store displays, posters, folders, sales aids, advertising mats will be provided.

The Garod line will be complete. GAROD quality will insure customer satisfaction. GAROD policies will protect your profit.

SEE US AT THE HOTEL STEVENS in Chicago, during the N. E. D. A. Convention Oct. 18 to 21 inclusive, for a frank discussion of what the GAROD "extra measure" can do for you.

LUCILLE MANNERS plans on a GAROD postwar console

a GAROD combination is JOHN BOLES' postwar choice

"Oklahoma's" JOAN ROBERTS chooses for her postwar radio... a GAROD Portable

GAROD RADIO

GAROD RADIO CORPORATION • 70 WASHINGTON STREET • BROOKLYN 1, N. Y.

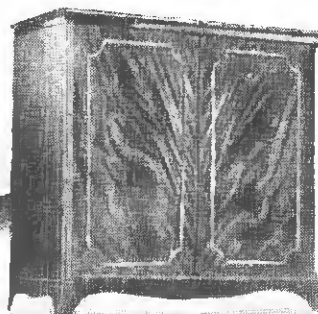

GAROD  **RADIO**

GAROD RADIO CORPORATION • 70 WASHINGTON STREET • BROOKLYN 1, N. Y.

SPRAGUE TRADING POST



A FREE Buy-Exchange-Sell Service for Radio Men



REPLACING WET ELECTROLYTICS WITH DRIES

In many cases—particularly in old sets—you can use Sprague Atoms (midget dries) in available Victory Line types to replace unavailable wet electrolytic capacitors. Atoms stand the gaff! A few precautions should, of course, be observed, and these are described in the Sprague "Victory Line" Catalog C-304. Write for your copy today.

WANTED—Std. make tube tester to test all tubes, must be A-1. Also want Gramatron HK-24 tube. Lewis Gordon, Box 426, Eureka, Mont.

WANTED FOR CASH—Hickok 155 traceometer. R. W. Ratliff, Santa Fe Motor Co., 418 Cerrillos Rd., Santa Fe, N. M.

FOR SALE—Western Elec. No. 18 receiver, 30 to 40 meg., 110V AC or 6V DC, 7-tube superhet with squelch, A-1 condition. James Lawless, 496 Pleasant Valley Parkway, Providence 8, R. I.

URGENTLY NEEDED—Pocket type multi-tester for servicing soldier's radios; also Echophone EC-1 or equivalent receiver. Pfc. David Ferber, Communications Plt. Hq. Co., 1st Bn., 276 Inf., APO No. 461, Ft. Leonard Wood, Mo.

FOR SALE—S-19 Sky Buddy comm. receiver, A-1 condition. David Zook, 328 Oak St., Pottstown, Pa.

FOR SALE—AC-DC phono amplifier with speaker and tubes; 6V-200V, tubeless vibrator; telegraph (knocker) key; xmitting condenser, socket, headphones, elec. clock, newsreel film, etc. S. J. Zuchora, 2748 Meade St., Detroit 12, Mich.

WANTED—3 iron core or triple tuned intermediate freq. transformers. One converter to i.f., one interstage and 1 i.f. to diode. Frequency must be between 450-500 K.c. Will swap any six of following tubes for these 3 transformers: 1-35Z5GT; 2-6K7; 1-6J5G; 1-35; 1-32; 1-C7G; 1-86M; 1-6F5; 1-1A7G. Roy Orvis, Box 340, Dryden, Ont., Canada.

FOR SALE—Portable Precision #700 V-O-M and tube tester; Dacca #501 tube tester, both in good condition. Also limited number of boxed and used tubes. Emil Altenbach, R. #11, Box 345-K, Cincinnati 31, Ohio.

FOR SALE OR TRADE—Port. phono pickup with turntable and case, also 5G4 tubes. Will trade for outdoor elec. radio service sign. Want high-ohm voltmeter. Payad Radio Service, 202 E. Main St., Staunton, Ill.

WANTED—Good tube tester; sig. generator, and other test eqpt. What have you? Wm. O'Brien, 609 W. 1st St., Fulton, N. Y.

TUBES WANTED—3525; 35L6; 12SK7; 12SQ7; 12SA7; 14Q7; 1H5G; 1T5GT; 1A7G; 1N5GT; 117Z 6GT/G; 9002; 9003. Frank Ura, Gen. Delivery, Gooding, Idaho.

FOR SALE OR TRADE—Audio transformers from dismantled radios, tubes, carbon mikes, 50 pound WD theatre AC excited 12" speaker, and other articles. Write for list. Want projector type baffle for 12" speaker; and Rider's 8-13. Olsons Radio Service, 743 1st St. North, Carrington, N. Dak.

FOR SALE—RCA-Rider Chanalyst like new, \$107.50; Dumont #184 3" oscillograph never used, \$65; 1 slightly used 2-speed turntable with fine crystal pickup, gear driven motor, \$50. Vito F. Daidone, 762-4-6 So. Orange Ave., Newark, N. J.

WANTED—SX9, 1936 Super Sky-Rider. Mention price and condition. Matthew Healey, 681 Harris Ave., Providence 9, R. I.

FOR SALE—Phono motors, heavy duty, adjustable speed, 10" and 12" turntable. \$12 each. Casey's Radio Service, 169 Hall Ave., Perth Amboy, N. J.

WANTED—1-1A7GT; 2-1NAGT; 1-1H5GT; 1-3Q5GT; 1-117Z6GT. New tubes preferred. Bernard Lubinski, 439 S. Olive St., South Bend 19, Ind.

FOR SALE—Used tubes: 6-81; 2-50; 12-01A (all RCA); also Weston #274 tube checker. Jay Radio, 2013-65th St., Brooklyn, N. Y.

WANTED—Short wave set, preferably inexpensive type. Cash. Mickey Berman, 1091 Ostend, Cleveland 8, Ohio.

FOR SALE—Custom-built 2 1/2 meter transceiver with 6J7G/BTX, 6J5GT, 6L6, 5W4, tubes, etc. Sell for cost of parts, \$25. New Shure crystal handy desk mike, \$6.50; DeJur Critic exposure meter for stills, \$17.50. L. F. B. Carini, Wolcott Hill, Wethersfield, Ct.

WANTED—Comm. receiver such as Hallcrafters S-19R, S-20R, or National NC-45. Also want RCA or Supreme oscilloscope. Vail Gwaltney, R. 2, Box 131, Smithfield, Va.

WANTED—A good late tube tester, also 5016 tube. Krasinske & Boguslaw Radio Service, 72 Klein St., Rochester 5, N. Y.

FOR SALE—Master 1/4 h.p. 110V AC motor, 60 cy. 3425 r.p.m.; motor generator 230V to 110V 60 cy.; 4-1/2 h.p. motors 110V AC 60 cy.; Robbins-Meyers 1/20 h.p. worm gear reduction drive 110V AC or DC; 4-1750 to 1 gear reduction boxes. Want 0-50V DC and 0-100 amp. DC meter, panel mtg. type, both to match. N. K. Stover, 1357 Hill St., York, Pa.

WANTED—Sig. generator having freq. range of 110 to 1600 ky. State make and price. The Radio Shop, Ferdon Ave., Piermont, N. Y.

FOR SALE—Complete ready-to-operate Junior mobile television unit; also Lafayette #417 Portable P.A. system complete. Write for complete details. Samuel M. Mack, 141 Summer St., Lowell, Mass.

WANTED—Supreme AC-DC volt-ohm-milliamper-mmfid. meter for Supreme Analyzer #385 or Supreme #85 analyzer in good condition. Alt Radio Service, 639 Franklin Ave., Lapeer, Mich.

FOR SALE—New Bogen complete portable sound system, including high fidelity Bogen amplifier, two heavy duty Magnavox PM speakers, RCA mike, and case. D. Jarden, 7149 Ardleigh Ave., Philadelphia, Pa.

FOR SALE—Almost new 6V vibrator power supply on aluminum chassis to deliver 300V at 100 ma. filtered output. E. T. Ackley, 1017 N. First St., Banning, Calif.

FOR SALE—Knight 30-watt deluxe amp. 6 and 110V; 65-watt AC system; 100-watt ditto; 14 Jensen 12" P.M. with Kainer baffles; 4 Jensen 8" drivers with Kainer trumpets; 55b Shure mike; Ampertite velocity mike. A. J. Resetic, 4406 N. Mozart Ave., Chicago 25, Ill.

WANTED—Will pay ceiling price for good quality hand key. Robert N. Hurst, 2418 Brighton Drive, Louisville 5, Ky.

WANTED FOR CASH—6SF7 tube; 1.4 volt tubes; 14Q7, 36L6, and 117Z6 tubes. For sale: Schick elec. razor, almost new; G-I LX phono motor, and Astatic crystal pickup model 07. Duncan's Radio Service, Longhurst, N. C.

WANTED—#188 or 188X Hickok sig. generator and RFO-5 oscillograph or earlier models. Any other freq. modulated oscillator or any oscillograph with video amplifiers considered. G. M. Elliott, 605 S. W. Blvd., Chicasaw, Ala.

WANTED—Complete phonograph or motor and turntable for 25-cycle operation. Cash. Geo. W. Van Loan, 75 Murray Ave., Greenfield Park, Quebec, Canada.

FOR SALE—R.M.E. comm. receiver, #0-D, in A-1 condition. Will trade for comm. recording outfit, or will buy latter for cash. Model Radio & Sound Co., 1004 Washington Ave., Racine, Wis.

WANTED—Hickok tube and set tester #510X; also 188X sig. generator or other instruments equally ranged. Bernard L. Camp, Two Rock Ranch, Petaluma, Calif.

WANTED—ROA Jr. voltohmmyst or AC-DC V-O-M for cash. Must be A-1. Peerless Radio Service, 3721 Geary St., San Francisco, Calif.

FOR SALE—ATR inverter 110V DC to 110V AC, 200 watts. 20" parabolic horn. 17" aluminum bell and steel back for up to 12" speaker; Supreme PA analyzer #595, 200 micro-amp. basic movement. A. Auerbach, 51 W. 174th St., Bronx, New York, N. Y.

FOR SALE—Standard teleplex code oscillator, practically new, with several rolls of Cont. code and inst. book. No key or headphones. J. H. Wickman, Box 267, Jonesville, Mich.

FOR SALE—Tubes: 37; 39; 6L6; 6V6; 6B6; 84; 7A7; 7T4. Godfrey Electric Store, Dover, Ohio.

FOR SALE—Three battery sets compl. with tubes and speakers; 1 Silver-Marshall 8-tube experimental set with tubes and dynamic; 1 tungar and 1 dry disc trickle charger. Ray Decker, 119 Pine St., Portland 4, Maine.

SWAP OR SELL—Meissner analyst #10-1154; Superior channel analyst; Superior sig. generator; 25-6E6; 6B8; 6F6; and 6L6. T. F. Waters, 211 E. 42nd St., Norfolk 8, Va.

FOR SALE OR TRADE—Audio transformers from dismantled radios, tubes, carbon mikes, 12" speaker, etc. Want projector type baffle for 12" speaker, Rider manuals 8-13. Olsons Radio Service, 743 First St. North, Carrington, N. Dak.

WILL SWAP—Back issues of popular Science Monthly for back issues of Radio Craft (Jan. 1942—Sept. 1944). Also want 2516, 6C5, 6J7, 1V tubes, and 100' of aerial wire. Thomas J. Lund, Box 12, Honeyford, N. Dak.

FOR SALE OR TRADE—2 1/2 meter receiver. Want small SW receiver, such as FB-13, SW-3, or EC-1. Dick Stroud, Box 13, Sims, Ind.

FOR SALE OR TRADE—Weston #301-0-1 mil. D-C meter and Weston #471 output meter, both perfect condition; also the following tubes: 6C5, 42, 48, 6K7, 6A4, 6H6, 6F6, 6B7, 12CS, 6AE7, etc. Need 12A8, 12SA7, 35Z8, 35L6, 50L8, and 25B8. Louis Walarin, 5415 S. Tripp Ave., Chicago 32, Ill.

FOR SALE—Five band 10-tube superhet comm. receiver, short wave, airplane beacon, standard broadcast, police and foreign, spreading range 8.5 to 2,000 meters, Virgil Calmer, Route 1, Box 57, Alpha, Ill.

YOUR OWN AD RUN FREE!

This is Sprague's special wartime advertising service to help radio men get needed parts and equipment, or dispose of radio materials they do not need. Send your ad today. Write PLAINLY or PRINT—hold it to 40 words or less. Due to the large number received, ads may be delayed a month or two, but will be published as rapidly as possible. Sprague reserves the right to reject ads which do not fit in with the spirit of this service.

HARRY KALKER, Sales Manager

SPRAGUE PRODUCTS CO., DEPT. RRT-104, North Adams, Mass.

(Jobbing distributing organization of products manufactured by SPRAGUE ELECTRIC COMPANY)



SPRAGUE CONDENSERS * KOOLOHM RESISTORS

Obviously, Sprague cannot assume any responsibility, or guarantee goods, services, etc., which might be exchanged through the above advertisements



Hi
Mom!

War's end! . . . A thick wedge of Mom's never forgotten apple pie instead of K Rations . . . Civies instead of Skivies . . . A table model radio instead of a walky-talky. Whatever war-born miracles may be reflected in tomorrow's radio, you can depend upon Fada to maintain its 25 year tradition for advanced design and dependable performance.

PLACE YOUR FAITH IN THE

FADA
Radio

OF THE FUTURE

Famous Since Broadcasting Began!

FADA RADIO AND ELECTRIC COMPANY, INC., LONG ISLAND CITY, N. Y.

Right — for Fighting Wings

In a modern bomber there are some six dozen places where radio and electron tubes find vital use.

Many of these uses were made possible by Sylvania's development of special radio tubes. For example — there are Sylvania tubes small enough yet powerful enough to operate effectively on standard storage batteries without need of extra, weight-adding generators.

With much of our production now going into such all-important service, you can be sure of one thing about its quality.

Every unit produced is designed and built to just one standard—the highest anywhere known.

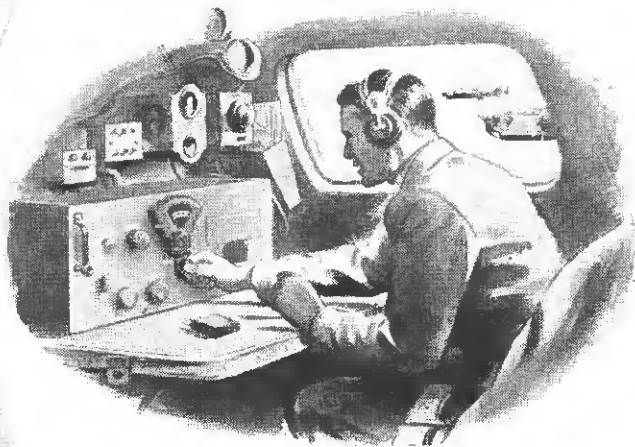

For security reasons, radio equipment actually used in fighting planes is not shown here.

Right — for Future Fliers



No one is yet prepared to say how much the availability of rugged, lightweight radio and electron tubes will hasten the coming of the safe, light family plane.

But, obviously, wartime lessons in the possible uses of such tubes hold great promise for future developments.

Naturally, for such uses, only the highest and most dependable quality will do.

And they will represent a field in which you will have special reason to look for the Sylvania symbol as the mark of a single standard, and that the highest known. Sylvania Electric Products Inc., Executive Offices: 500 Fifth Avenue, New York 18, N. Y.

BUY WAR BONDS

FOR THE DURATION

America's war program gets first call on all our products, resources and skill.



SYLVANIA

ONE STANDARD—THE HIGHEST ANYWHERE KNOWN

RADIO TUBES

Sylvania was first to propose a standardized 6.3-volt radio tube for both home and automobile radio sets. Such standardization eliminated about half of the previous tube types and reduced cost.

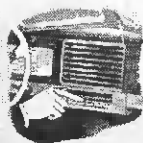

ELECTRONIC DEVICES

Heart of your postwar television set will be an electron tube. Such tubes are one of many types Sylvania is even now producing. Work in the field of electronics is a definite part of Sylvania's activities.



LAMPS AND FIXTURES

Most of Sylvania's Incandescent Lamps and Fluorescent Lamps, Fixtures and Accessories are now going into Victory-effort use. But the day is coming when either type of lighting, made by Sylvania, will be readily available for your home.





SOME WILL BE OUTSTANDING !!!

Sure . . . all post-Victory radio sets will be new and different. They will be replete with enough new features, improvements and gadgets to astound most dealers . . . certainly all prospects; BUT (and it's a BIG "BUT") you can be sure that *some will be outstanding!*

You guessed it . . . Maguire Industries, Inc., Home Radio (Electronics Division) will have a prominent place in this outstanding group. Here's the reason: Maguire Industries' policy from the beginning has been based on the assumption that only the best research-engineering brains can conceive, design, and engineer products that will be outstanding in their field. Maguire Industries has been successful in obtaining the services of men acknowledged to be the best in the electronics field.

These scientists have produced a line of Maguire Home Radio Receivers devoid of all the common and uncommon "bugs" that

horrass listeners. This is a radio line you will want to display and sell. It guarantees customer satisfaction and the real profits that go with speedy sales and trouble-free operation.

Maguire Industries has won exceptional merit in wartime production . . . in the electronics field; in the small arms field ("Tommy" guns and other small arms); in the food processing field; in the oil producing industry. Now, Maguire Industries has turned the talents of its large staff of scientists, engineers, and technicians to creating products for after-Victory use.

A tip that costs you nothing . . . investigate the Maguire Home Radio Receiver Line now! You'll be surprised with Maguire Industries' liberal dealer policy as well as the exceptional radio. For full information, write Maguire Industries, Inc., 342 West Putnam Avenue, Greenwich, Connecticut today!

A NEW NOTE IN HOME RADIO



MAGUIRE INDUSTRIES, INC.
ELECTRONICS
division

GREENWICH • STAMFORD • BRIDGEPORT • NEW MILFORD • NEW YORK

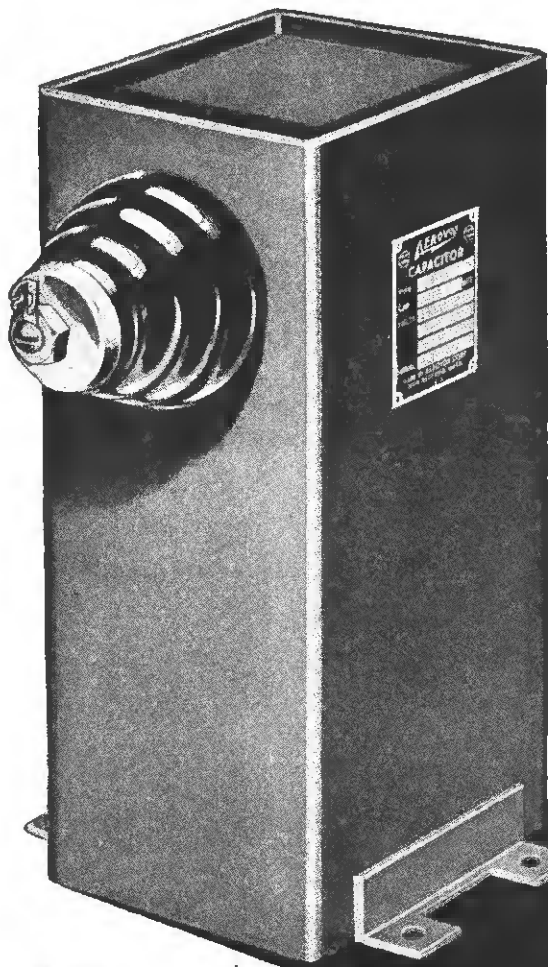

TODAY...

Aerovox Capacitors Go to War

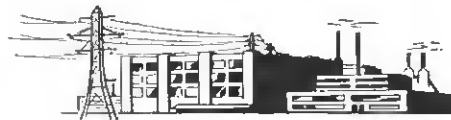

TOMORROW...

**Aerovox Capacitors Help Build
Peacetime Progress**

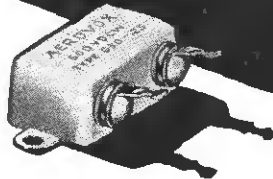

Electrolytic capacitors in the widest range of types, containers, capacities, voltages, mountings, terminals.

Paper capacitors, including uncased sections, tubulars, metal-can, bakelite case.

Oil-filled capacitors, ranging from tiny tubulars and "bathtubs" to large transmitting capacitors, for heavy-duty applications.

Motor-starting capacitors for electric refrigerators and other appliance purposes.

Plug-in electrolytic and paper capacitors for ready testing and replacement, especially in equipment subject to constant service.

ETC. ETC.

• Today Aerovox is all-out for the war effort. Winning the war comes first. Aerovox personnel has expanded several fold since Pearl Harbor. Close to half a million square feet in two plants are now devoted exclusively to capacitor production.

Tomorrow, when victory shall have been achieved, Aerovox once more will be ready as never before to serve peacetime progress—to meet the requirements of the expanded radio industry, the refrigerator and other home equipment needs,

the industrial and power requirements, and the booming electronic era. Special capacitors of yesterday shall be the commonplace types of tomorrow. And new standards of life and performance can certainly be taken for granted.

CONSULT OUR JOBBER . . .

Today, let him help you with your wartime servicing needs. Tomorrow, when peace returns, count on him as never before for your expanded requirements.

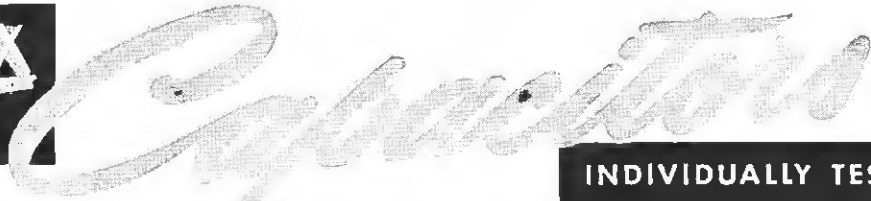

INDIVIDUALLY TESTED

AEROVOX CORPORATION, NEW BEDFORD, MASS., U. S. A.

SALES OFFICES IN ALL PRINCIPAL CITIES

Export: 13 E. 40 St., New York 16, N. Y. • Cable: 'ARLAB' • In Canada: AEROVOX CANADA LTD., HAMILTON, ONT.

STEWART-WARNER

**HAS BEEN TOO BUSY WORKING FOR G.I. JOE
TO "BEAT THE DRUMS"**



**But When the Big Job is Over, You Can Depend on Stewart-Warner
to be Ready With Top Radio Values and Outstanding Performance**

YOU haven't seen much in print about Stewart-Warner Radio. Since Pearl Harbor we have been much too busy making radio devices for the armed services... we haven't had time to go out and "beat the drums."

We believe that the primary job is to make more and better radio, communications and direction finding equipment... to make it faster and ship it on time. For that is what will help bring our boys home sooner, which everyone wants first of all.

So, we haven't had much time to tell the world how *much* we're doing or how *well*. But you can bet your bottom dollar that Stewart-Warner has been doing an outstanding job.

The proof is that only recently, in Chicago, Stewart-Warner shared in the Navy's special "Certificate of Achievement" for an outstanding contribution to the war effort... the first time in Navy history that such a citation has been made.

And here are some of the accomplishments of Stewart-Warner that helped bring about the award:



MORE THAN 1200 CARLOADS SHIPPED SINCE PEARL HARBOR!

Totaling more than 12,000,000 pounds of radio, communications and direction finding equipment... or a train nearly 12 miles long. And—*shipped on time!*

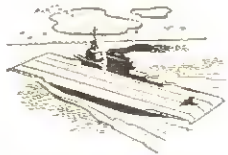

Equipment for the NAVY

... Radio Equipment and electronically controlled instruments.



Equipment for the SIGNAL CORPS

Airborne and ground operated signalling and direction finding equipment.

Equipment for the AIR FORCES

Electronically controlled aircraft instruments, two-way radio transmission and other devices.



Equipment for the TANKS

Radio transmission equipment, electronically controlled devices still too new to talk about.



So, make no mistake about it... **WHEN THE WAR IS OVER, STEWART-WARNER WILL BE OUT "BEATING THE DRUMS" FOR THE GREATEST, MOST PROFITABLE RADIO LINE IN ITS 20 YEAR HISTORY!**



WHAT FREQUENCY RANGE DO WE NEED FOR HIGH FIDELITY REPRODUCTION?

"Frequency Range and Power Considerations in Music Reproduction" is the title of number three JENSEN Monograph, now ready for mailing. With the approach of FM, Television, High Quality Recording and other advances in the audio electric art, calling for new and increased emphasis on the requirements of High Fidelity Sound Reproducing equipment, this subject is both timely and pertinent.

Do you know the maximum, useful audio frequency ranges under actual listening conditions? Do you know how frequency range is limited even if perfect transmission, reception and reproduction were possible? Or how much change in high frequency cut-off is required to be just noticeable to the listener?

All of these questions, and many more, are answered in this latest JENSEN Monograph. Based on an extensive examination of authoritative work in this field, treatment of the subject is such that it will be found valuable by professionals, the trade, educators and the public.

If you are interested in sound reproduction, you need this up-to-the-minute information. Get your copy today from your JENSEN distributor or dealer, or send 25c to:



Series So Far Issued

- No. 1. Loud Speaker Frequency-Response Measurements.
- No. 2. Impedance Matching and Power Distribution.
- No. 3. Frequency Range in Music Reproduction.

Watch for the next issue!

Free to men in the Armed Services and to Colleges, Technical Schools and Libraries.



Jensen

JENSEN RADIO MANUFACTURING COMPANY
6625 South Laramie Avenue
Chicago 38, Illinois

- Send me Loud Speaker Frequency-Response Measurements
 Impedance Matching and Power Distribution
 Frequency Range in Music Reproduction
 (Check one, two or three. Send 25c for each book ordered.)

NAME _____
 ADDRESS _____
 CITY _____ ZONE _____ STATE _____

LOST!... a needle!

FOUND!...

a thrilling New World of Sound!

ANOTHER CROSLEY USER-PLUS is the Radio-Phonograph Combination with the exclusive, patented Floating Jewel* Tone System.



Instead of the old-fashioned sharp-pointed needle a permanent sapphire stylus is used. As the name indicates, this stylus "floats" in delicate contact with the sides of the sound groove in the record. It never touches the bottom of the groove where the ordinary sharp needle plays.

This means "Goodbye" to needle scratching, hissing, chattering—no longer do surface noises fog or jam the clear, pure tone. Even old records give forth new richness of sound and new records play with full clarity and brilliance. All records, new and old, will last up to ten times longer with the Crosley Floating Jewel* Tone System. And its permanent stylus puts an end to needle changing.

Just such a *plus* as this gives every Crosley product extra preference in users' homes — and extra buyer appeal on the sales floors of merchants.

It is Crosley's aim to design such excess values into all Crosley products — those scheduled to come after the war as well as the familiar appliances already known to millions.

*Reg. U. S. Pat. Off.

CROSLEY

THE CROSLEY CORPORATION

CINCINNATI, OHIO

Peacetime manufacturers of Crosley refrigerators, radios, other household appliances and the Crosley Car, Home of W.L.W., "The Nation's Station."



An Army that Travels on its Ears

CERTAINLY, today's armies have Stomachs, but they have something Napoleon's armies *did not* have . . . Ears. Ears that can hear, not for just a few feet, but over any distance on Land, in the Air and on the Sea. Electronic ears that link every unit of our fighting forces in instant and complete Communication . . . that spell the difference between success and failure.

As a pioneer designer and manufacturer of

THE ROLA COMPANY, INC. • 2530 SUPERIOR AVENUE • CLEVELAND 14, OHIO

Sound Reproducing Equipment, it is only natural that Rola should be in the forefront of the effort to supply our Military with the delicate, dependable components for Communications Systems... Headsets, Transformers, Coils and other Electronic parts. Knowing the power of Communication on the Home Front, it is only natural that Rola suggests, "Consider everything you SAY; check the source of everything you HEAR."

ROLA

Let's do more



in forty-four!

MAKERS OF THE FINEST IN SOUND REPRODUCING AND ELECTRONIC EQUIPMENT
RADIO & Television RETAILING • October, 1944

Earmarked A PROFIT-MAKER!



THE American people are quick to recognize quality—for it is a national characteristic to want to own the finest. That is why astute, far-sighted dealers are saying:

PHILHARMONIC is Earmarked for Profits.

The incomparable performance of the new PHILHARMONIC—*evident at first hearing*—makes it obvious why it is earmarked for the discriminating music lovers in your community—and therefore earmarked for profitable sales and prestige. You'll want the exclusive privilege of introducing it to your friends, your patrons, your community! You'll want this superb instrument in *your own home*.

Even to radio and music dealers long accustomed to distributing top quality products, the

performance of the PHILHARMONIC is a revelation. No other instrument of its kind has the ability to recapture, with concert hall realism, the *entire* audible spectrum.

Those who hold the PHILHARMONIC franchise for their community will be supported by an impressive national advertising campaign reaching 20,000,000 people every month.

They'll enjoy the support, too, of unusually elaborate promotional material for their own use—material that will enhance *locally* the distinction and pulling power of PHILHARMONIC *national* promotion.

PHILHARMONIC RADIO CORPORATION
524 East Seventy-Second Street, New York

Philharmonic



TRADE MARK

RADIO · PHONOGRAPH

"Ham" Radio and

HYTRON

PAST

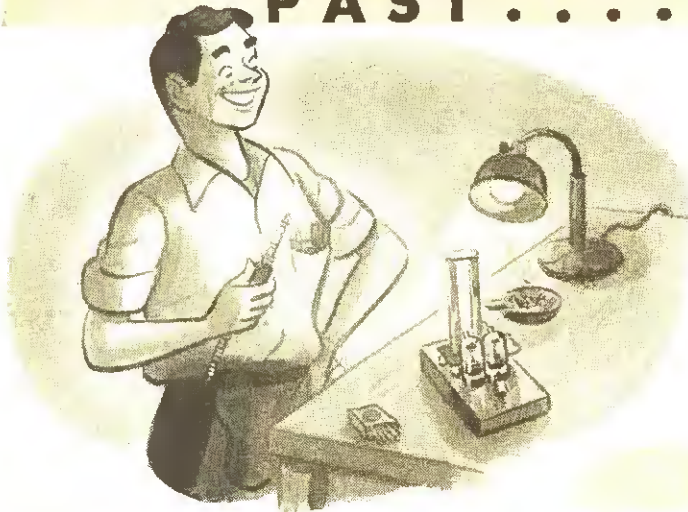

THE radio amateur trained himself during peace to be invaluable to the Nation during war. Specializing on tubes exclusively designed for ham radio, Hytron when war began was prepared for immediate and direct conversion to war production. Hytron transmitting and special purpose tubes proved by the ham were ideally suited—with little or no changes—to military applications. Years of practical experience made Army and Navy specialists of radio amateurs overnight. Peacetime tools of these same hams, Hytron tubes joined immediately this new fighting team.

HAMS with the Services in all parts of the world know the war job Hytron is doing. High-speed receiving tube techniques plus know-how derived from special purpose engineering of tubes for the amateur, make possible a flood of dependable Hytron radar and radio tubes to these fighting ex-hams and potential hams. Proud of winning the Army-Navy "E" for its performance on a huge production job, Hytron is also proud of its ham friends who are transforming innocent-appearing Hytron tubes into deadly weapons.

. . . . PRESENT



THERE should be no concern about adequate post-war amateur frequencies. Excellent wartime performance on far-flung battle fronts has made for ham radio many enthusiastic and influential friends. The ARRL reports that it looks forward with absolute confidence to the opening of new frontiers in expanded frequency ranges to be made available to the post-war amateur. Hosts of hams will return to their old friend, Hytron. For the more familiar lower frequency bands—the very high frequencies—or the new superhighs—their choice will be Hytron.

FUTURE



OLDEST EXCLUSIVE MANUFACTURER OF RADIO RECEIVING TUBES

HYTRON CORPORATION

ELECTRONIC AND RADIO TUBES
SALEM AND NEWBURYPORT, MASS.



BUY ANOTHER WAR BOND

RADIO & Television RETAILING • October, 1944



LOW INVENTORY



NO LABOR PROBLEMS



Merchandise Available NOW!

NU-ENAMEL Can Mean Bigger Profits For YOU!

Individualized "Paint-it-Yourself" Departments are establishing sensational sales records for progressive Nu-Enamel Dealers all over the country. And the beauty is, every one of these dealers is building a steady flow of customer store traffic that will ring up cash register profits on other lines in the postwar future. No other product offers the profit and business building possibilities of a Nu-Enamel Franchise!

Pre-tested Selling and Advertising Methods!

The exclusive Nu-Enamel-consumer merchandising program is one of the greatest assets a store can have. It provides the proven sales stimulating plans that make continuous money for all Nu-Enamel Dealers. Franchises are available to responsible retailers in many locations. Write for complete information today.

START YOUR OWN "Paint-it-Yourself" DEPARTMENT

NU-ENAMEL CORPORATION
 8 South Michigan Ave., Dept. 20
 Chicago 3, Illinois

We are interested in learning how Nu-Enamel can increase the sales and profits of our store.

NAME

ADDRESS

MAIL THIS OPPORTUNITY COUPON NOW!

He'll Want the Finest!



HOWARD

• We are making plans and perfecting production designs right now to bring you as quickly as possible the finest Howard Radio Receivers and Radio-Phonograph-Recorder Combinations you ever saw and heard.

Naturally, we are continuing to devote 100% of our skilled craftsmanship to Uncle Sam and will do so until complete Victory is ours. But like Peace itself, Howard production for Peace is "just around the corner." As always, you can count on Howard to bring you the finest in entertainment radio.

BUY MORE WAR BONDS FOR VICTORY!



America's Oldest Radio Manufacturer

HOWARD RADIO COMPANY, 1731-35 Belmont Ave. CHICAGO 13 ILLINOIS

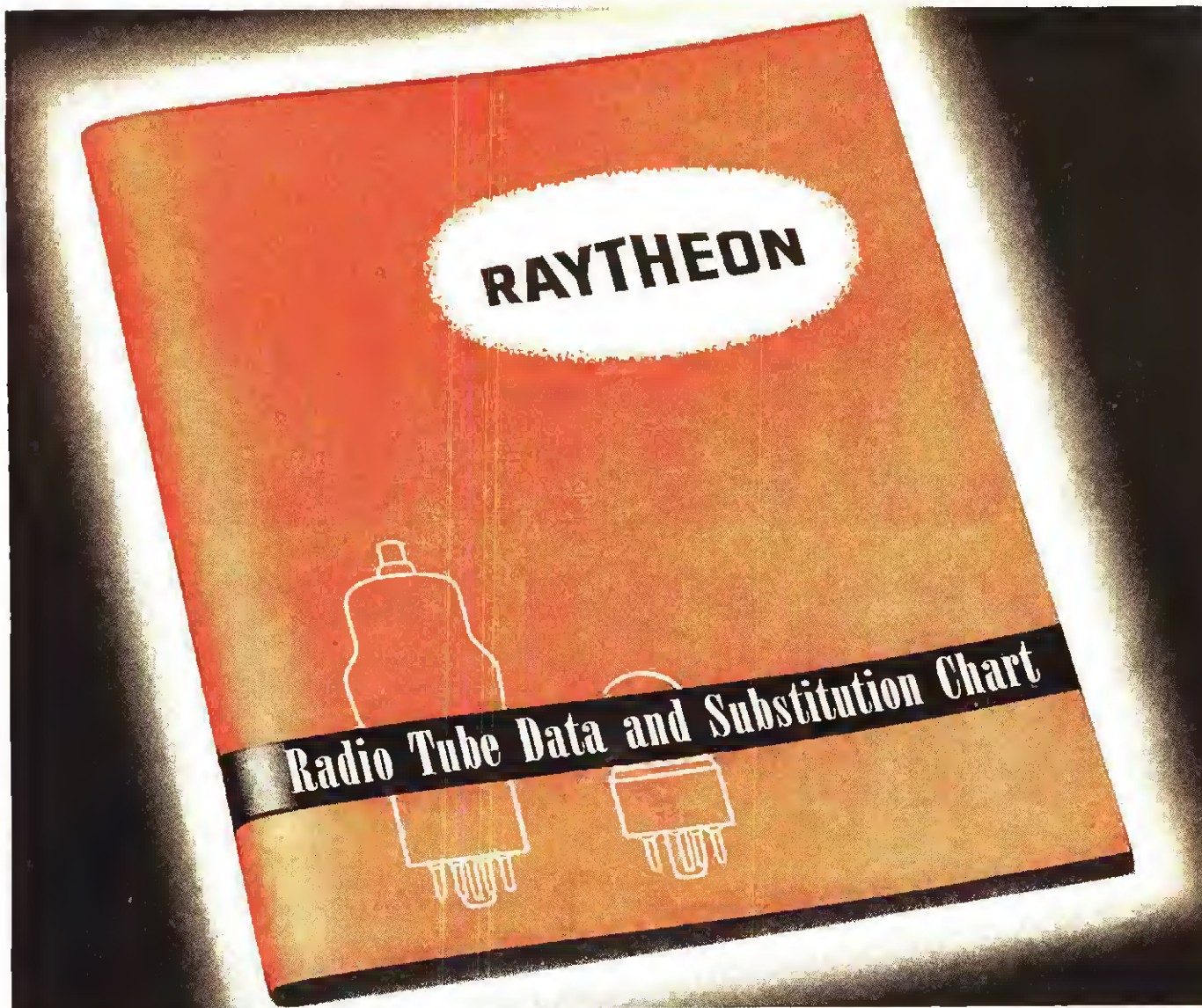

NEW COMPLETE RADIO TUBE DATA BOOK BY RAYTHEON

THE new complete data on tubes, including characteristics, outlined drawings and basing diagrams of all standard receiving tube types; simplified interchange information including over 1600 substitutions; hearing aid tube data and technical information regarding radio panel lamps. All this is included in the new Raytheon Tube Data and Substitution Chart prepared by the Technical Service Department of Raytheon Manufacturing Company.

The value of the technical information in this manual is inestimable and yet it may be obtained FREE from your Raytheon receiving tube distributor. Every-

one concerned in the repair and maintenance of radios must have this ready reference book.

This manual is the first step in a tremendous merchandising plan which will bring you better business. This program teamed up with the superior, "Plus-Extra" quality Raytheon Tubes, will assure you of better customer goodwill, faster turnover and greater profits.

Raytheon Manufacturing Company

RADIO RECEIVING TUBE DIVISION

Newton, Massachusetts • Los Angeles • New York • Chicago • Atlanta



All Four Divisions Have Been Awarded Army-Navy "E" With Stars

RAYTHEON

High Fidelity

RADIO AND ELECTRONIC TUBES



DEVOTED TO RESEARCH AND MANUFACTURE OF TUBES FOR THE NEW ERA OF ELECTRONICS



DOUBLE WINNERS

STROMBERG-CARLSON'S WARTIME ADVERTISING — AND STROMBERG-CARLSON'S POSTWAR RADIOS!

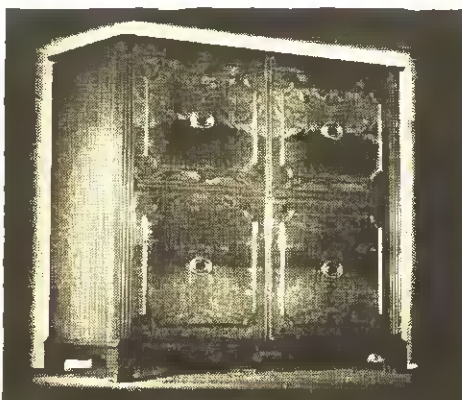

Stromberg-Carlson, Rochester 3, New York
Radios, Television, Telephones, and Sound Equipment

What wartime radio advertising can show such a record of dealer approval—and of public readership—as the current Stromberg-Carlson pages in the national magazines? *None*—the Daniel Starch advertising check-ups have proved that, *plenty!*

And the postwar Stromberg-Carlson FM and AM radios, radio-phonographs, and television sets will be equally far out in front. Tailor-made to the postwar market—as established by our recent 5,000-radio home market survey—they will give the public exactly what it's looking for.

This 5,000-radio home survey brings home clear as a bell the buyers' tremendous insistence on top quality in radio equipment. They expect and will seek out the very best...and back up their insistence with plenty of cold cash.

The distribution of your radio sales promises some important changes, too. Changes in the ratios between radios and radio phonographs, between consoles and table models. Changes and improvements which people want, and which will be reflected in all postwar Stromberg-Carlson equipment... a pretty pleasant prospect for every Stromberg-Carlson dealer!



HERE'S THE **STROMBERG-CARLSON** POSTWAR SET-UP IN 21 SECONDS READING TIME!

1 We will have—soon after Victory—a fine line of Stromberg-Carlson FM and AM radios, phonograph combinations, and television receivers in a wide range of prices.

2 We will have a policy of distribution planned to give every Authorized Dealer a good profit opportunity on the Stromberg-Carlson line.

3 And the Stromberg-Carlson name will be even more widely and more favorably known than ever before.

O. H. CALDWELL, EDITOR
480 LEXINGTON AVE.

RADIO & Television RETAILING

Including Radio and Television Today

M. CLEMENTS, PUBLISHER
NEW YORK 17, N. Y.

THE JOB AHEAD FOR RADIO JOBBERS

The Electronic Parts and Equipment Industry Conference, scheduled to be held October 19, 20 and 21, at the Hotel Stevens, Chicago, is of timely significance to all firms and individuals in the radio and electronic trades.

Coming as it does in a period fraught with problems of reconversion, manufacture and distribution of civilian goods, as well as the maintenance of present and future war production, the conference will serve both the war effort and the industry in an effective and result-getting manner.

Distribution Difficulties

Problems of distribution confronting the industry during these unsettled times will be discussed by leaders in the Association of Electronic Parts and Equipment Manufacturers (formerly the Sales Managers Club, Western Division), the Sales Managers Club, Eastern Division; National Electronic Distributors Association and the Parts Division of the Radio Manufacturers Association, as well as by Government officials from Washington.

Topics scheduled for discussion include distributing ethics, the entrance into the field of new wholesaling organizations, standardization plans, postwar government regulations, crusades against price-cutting, etc.

One of the reasons the electronic industry will be "ready to roll" without delay when the "go" signal is given for civilian manufacture is that this industry, taking a realistic viewpoint of situations affecting its business, has

cooperated unselfishly in threshing out mutual problems. It may safely be assumed that out of the important conferences at Chicago will come new and better distribution techniques to aid (1) the war production effort now, and (2) the civilian distribution market when M-Day—meaning the day merchandise will again appear in quantity on dealers' shelves—arrives.

Many Millions thru Jobber Channels

In the 12 months after M-Day, there will have to be distributed—

16 million radio sets.....retail value	\$733,000,000
60 million replacement tubes	retail value 65,000,000
Repair parts	valued at 90,000,000
Batteries for 3 million portable radios	valued at 12,000,000
Records—200,000,000	valued at 100,000,000

Total radio merchandise.....	\$1,000,000,000
Electrical appliances handled by radio dealers	800,000,000

GRAND TOTAL \$1,800,000,000

The above assumes that no substantial number of television sets will be distributed during the first year after M-Day. Later on, television volume may be expected to duplicate in dollar volume that of radio sets—say one-sixth to one-quarter as many units as a sixfold to fourfold unit valuation.

This is the Big Job before U. S. radio jobbers as M-Day approaches, and billions of dollars worth of merchandise start to move.

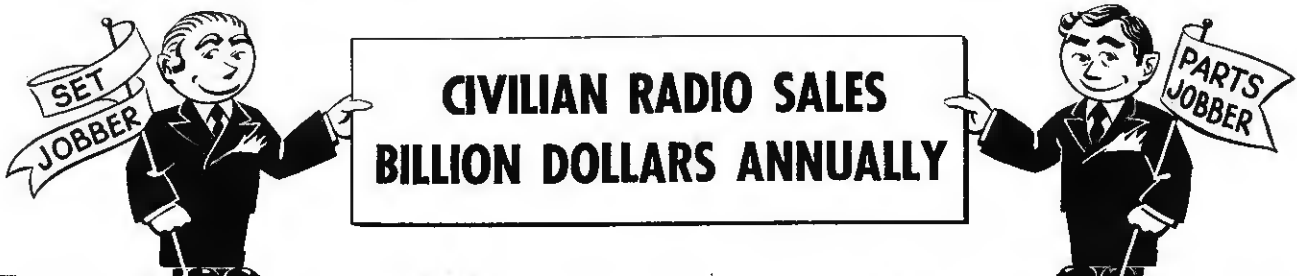

RADIO Appliances, Music,

ALL ABOARD FOR CHICAGO, OCT. 19-21! Big Electronic Conference scheduled for Hotel Stevens under auspices of all industry groups, is attracting unprecedented attention and attendance. Everybody seems to be getting ready to go. Important postwar plans will be in the making, in those meetings along the Boule Mich!

FCC ALLOCATION HEARINGS now on in Washington (and expected to continue in November) were called as a result of U. S. State Department's demands for a generally acceptable radio-channel set-up on which can be based international treaties immediately after Victory in Europe. Taking part in current hearings are 75 different radio interests. Frequencies under consideration range from 10 kc to 30,000,000 kc.



IRAC, THE IRASCIBLE—Interdepartmental Radio Advisory Committee, whose members represent all Government departments, including Army and Navy, has presented some rather startling recommendations that would (1) eliminate international shortwave listening, and (2) eventually relegate television to the very high frequencies between 450 and 1,000 megacycles. IRAC is the President's official board of advisers on government radio matters.

RADIO TECHNICAL PLANNING BOARD, made up of some 150 radio experts representing cream of radio industry's specialists, has been working for a year to develop a unified radio-allocation policy, but its conclusions were still admittedly incomplete when FCC call came, at State Department's behest. RTPB panel chairmen are therefore appearing individually at current hearings, leaving to FCC the problem of coordinating recommendations.

WESTERN UNION UHF—Surprise applications, disclosed during FCC hearings, were Western Union telegraph company's demands for high-frequency channels for routing messages by radio. Facsimile pick-up of messages is also to be used extensively, postwar, to save boy-power.

MOTION-PICTURE DEMANDS for theatre television have introduced new big headache into the video setup. A dozen motion-picture companies want two channels each, one for distributing to major city theatres, one for outlying neighborhood houses. Each company is also asking for a couple of "pick-up" channels, to funnel news events to central distributing points. Wide, "high-fidelity" channels are demanded, capable of much more detail than present 525-line home video.

BARRING OF INTERNATIONAL BROADCASTS, recommended by both State Department and IRAC, may be move to quiet international misgivings. Rumor is that some of our Allies are touchy about American international broadcasts "going direct," via short-wave, to their nationals. Instead, these objecting nations propose to operate own local broadcast stations, as exclusive sources of programs for their citizens. Then any time material from U. S. is desired (by them) program would cross ocean by communication channel to particular foreign station, for re-broadcast. Full development of such a plan would of course make useless present international bands on some 30 million radio sets in U. S. alone.

WELL DONE, RAY ELLIS!—Radio-Radar Division of War Production Board has just had the resignation of Ray Ellis, its energetic director, who tirelessly drove radio-electronic production up to the four-billion-dollar mark. Mr. Ellis returns to his old company, General Motors, at New York. Lew J. Chattan, of Fada fame, has been appointed director to succeed Ellis.

THAT HURRICANE PACED BY RADIO—While last month's hurricane was aborning in the Caribbean, the University of Florida was trying out its radio detection method. Center of any hurricane is usually source of vigorous static. By "ranging" this static with directive antennas from two widely separated positions, movement of the twister can be plotted from a safe distance.

RMA PARTS TRADE-SHOW IN 1945 has been authorized by RMA, providing Germany collapses before April 30. Show will include all parts and components, tubes and also transmitter components, but not receiving sets. Time and place of show will be decided later.



MICRO-WAVES TO THE FRONT as spotlight turns on the ultra-high frequency channels for television and other services. Where radio waves used in ordinary broadcasting measure about 1,000 ft. long, the new micro-waves scheduled for television's future caliper five or six to the foot.

POSTWAR EMPLOYMENT DOUBLE that of the last normal pre-war year is predicted for the radio manufacturing industry. This estimate is based upon reports from a large number of radio-set makers, contrasting their 1941 and 1945 positions. Does this in turn mean doubled radio-set output, or twice 13 million home radios in '45 or '46?

INTERNATIONAL HARVESTER CO. has announced that it will make household electric refrigerators and home freezers postwar.

and Television TODAY

PAGE SOLOMON AGAIN! Services of a very wise man will be needed when it comes time to allocate radio tubes between the radio-set makers racing for the postwar home market. Tubes, cabinets and possibly resistors will be the bottlenecks. At the outset probably only 25 per cent enough tubes will be available. Who will get what?

NEW HOME-RADIO NAMES are appearing, among them Bendix, Keith, Lear, Maguire, Pacific, Sheridan and Westinghouse. For a full list of all manufacturers expected to be making home radios after V-day, see page 118.

TAXI SPEEDUP BY RADIO may be expected in Cleveland, now that the Yellow Cab interests there have been granted radio wavelengths for dispatching taxicabs into city areas that suddenly need taxi service. No longer will idle cabs linger in one part of town while a taxi shortage exists elsewhere. The new "radio dispatcher" will keep 'em all rolling!

BOSTON CONFERENCE ON DISTRIBUTION will be held Oct. 16 and 17 at Hotel Statler. Thomas F. Joyce of RCA, Camden, N. J., will talk on "Television and Postwar Distribution." Dr. Paul H. Nystrom of Columbia University will discuss coming changes in marketing methods.

FOOT-CONTROLLED RADIO FOR VETS—Philco has presented a specially-made radio equipped with two foot-pedals (one a switch and the other a station selector) to the Valley Forge General Hospital at Phoenixville, Pa., for two overseas veterans who are blind and armless. Valley Forge is one of the hospitals where wonders are being accomplished in medical plastics.

BENDIX VS. BENDIX—Some confusion appears to be ahead between long-established Bendix home washer and new Bendix home radio to be brought out by Bendix Aviation group. There is no corporate connection between the two companies marketing these two home devices. The public will be puzzled; jobbers and dealers may get into some knots, too, when distribution paths cross!

CHRYSLER'S AIRTEMP DIVISION has developed a compact, custom-built refrigerator for airplanes, using aluminum in both cabinet and compressor construction, which may influence postwar home boxes. The 4¼-cu. ft. unit requires less than 3.5 sq. ft. of floor area. Aluminum direct-expanding evaporator has two ice trays, freezing about 3 pounds of ice at one time. Total weight is but 106 pounds.

SAMPLE SURVEY OF DISTRIBUTION COSTS for RMA has been completed under direction of Ben Abrams, chairman of RMA committee. Study covers six cities with 250 retail outlets in eight different classes.

A SPOKESMAN FOR BOEING tells us that, as far as he knows, the aircraft company has no intentions of manufacturing radio sets or electrical appliances for the home in the postwar period.



UNNECESSARY TRAIN WRECKS continue to call attention to need for radio on the railroads so that train crews can keep in continuous touch with the dispatcher and other nearby trains. Recent wreck of Candidate Dewey's special, which ran into stalled passenger train ahead, was example of accident that radio communication would have avoided.

ELECTRIC DISH-WASHERS will be added to the laundry-equipment line of the Hurley Machine Co., makers of Thor products.

NON-AUTOMATIC HAND IRONS seem doomed after the war. The Underwriters Laboratories will not approve any non-automatic, after the war ends.

"SUN-TAN IN YOUR SEDAN" will be slogan of Chicago manufacturer, Sun-Kraft, which has designed a small ultra-violet lamp to be operated from vibrator off car battery. Lamp can be hung on dash or elsewhere, and will also sterilize air in the car.

"VOICES OF THE MONTH"—Speech Characteristics of the Presidential Candidates

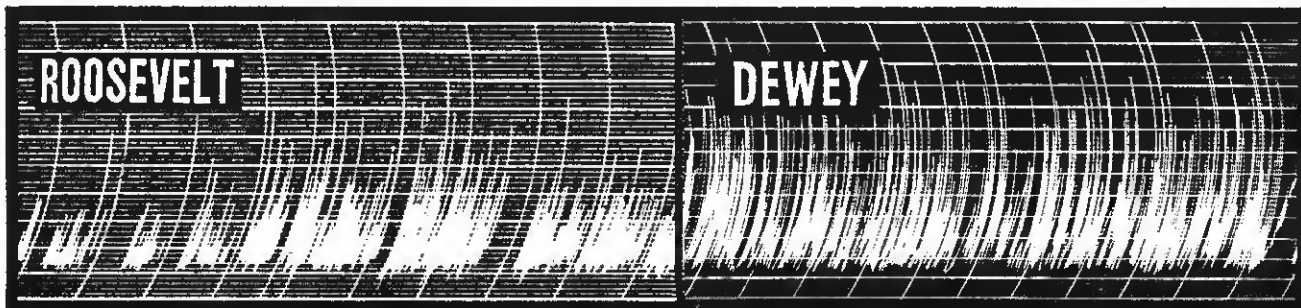

BLAIR F. UBER CENT

"Looking Ahead" to



Uber, Indiana, Pa., counts 56,000 potential customers in his trading area.

Having purchased heavily, Uber has big stock of new radios, many still crated.

He carries about 15,000 records, 1,100 albums.

In 1943, Uber sold 350 Motorola car sets—more than one a day.

His volume for 1943 was \$73,000.

Keeping overhead down is a hard-and-fast rule here.

Uber gives no out-of-store demonstrations.

He has always financed time payment sales, and has repossessed but 25 radios out of 15,000 sold.



• Although wartime shortages have forced many dealers to turn to sidelines to bolster their dwindling stocks, Blair F. Uber of Indiana, Pa., finds himself in the unique position of having the largest radio inventory in his community. The retail radio dealer who can boast of a supply of new radios on hand in 1944, is a man who makes news.

Uber realized that a situation of scarcities might develop, and as far back as April, 1942, he had the largest radio stock in the state. Still in the lead, he can now look forward to selling the sets he has in stock to some of the 56,000 potential customers in his trading area. This area has been producing about \$6,000 a month for him, against a fairly modest overhead, in the last three years.

Another characteristic example of the Uber foresight is that his subscription to RADIO & Television

Blair F. Uber, shown here in front of his Indiana, Pa., store, looks forward to the day when merchandise will become available—even though he has managed to maintain a large radio inventory during wartime.

Radio-Appliance Sales

RETAILING is paid up at the present time for 12 years in advance.

Uber owns the building in which his store is located at 618 Philadelphia St., and has about 4,000 square feet of floor space. He still keeps his radio playing softly throughout business hours to attract sidewalk strollers. His display room with its 30 ft. ceiling, is spacious and well laid out, despite the fact that it is filled to the aisles with consoles and radio-phonograph combinations, plus a continuing stock of about 15,000 records and 1100 albums.

Large Stock Inventory

When the manufacture of radios was frozen the Uber store had a total of 1500 sets on hand. Uber had been carrying about a dozen lines at the time, and some of these sets, in their original cases, still remain in the ample basement. All new table models have been exhausted since then, but Uber has a "used" stock of several hundred small sets, which he repairs and sells in sufficient volume to maintain a lively trade.

The store customarily stocks the usual appliances, but his small appliance business in general is now confined to selling used and reconditioned units. Washers and electric refrigerators are chiefly memories, but Uber does have a small stock of new ice refrigerators. The sale of fluorescent desk lamps has flourished in the past few years, with local students in this college community clamoring for these study lamps.

Demand for Motorola car sets also continues and some new ones are still on hand. In fact, the sale of 350 of these in 1943—more than one per business day—was a helpful item in the year's \$73,000 volume.

Auto radios form a consistent part of the customer demands on the shop,

and keep the staff busy. Uber employs the same three repair experts that he had in normal times, and their activity shows a definite profit. There are no women on the staff, although Uber would have no objection to employing women if there were occasion for it. In his 15 years in the business it has not become necessary, and his regular force has been knit into a family unit.

Mr. Uber has always financed all his own time payment sales, and he has done so practically without a loss. It has been necessary for him to repossess only 25 radio sets out of some 15,000 that he has sold. This is about fifteen one-hundredths of one per cent to be refigured for a partial loss on all his dealings. The actual dollar loss is so small as to be negligible.

Keeps Overhead Low

Uber's experience has taught him that to keep overhead within bounds it is necessary to restrict some services. He refuses to give demonstrations outside the store for that reason. He considers the practice of selling on approval equal to renting merchandise without a fee. He feels that few benefits can result from encouraging either of these policies. His guarantee of performance to the buyer is his way of proving that no risk is involved in buying directly from the floor. By adhering to these rules, Uber feels sure that when he makes a sale, it will stick.

Another factor involved in Uber's control of overhead is his ownership of the building. The top floor furnishes space for office and lodge rooms, and the rental naturally fits into the credit side of his business ledger.

So far there has been no boost in costs to require any particular price

change, and ceilings have worked no hardship in either new or used goods.

The Uber store has not found it necessary to stock up with emergency merchandise outside of the regular lines of the radio and appliance dealer. There has always been a small side line of music boxes and similar novelties, and that continues. Where other dealers have had to put in toys and floor lamps and furniture and crockery, however, to substitute for their regular stock, Mr. Uber has never found that he had to. He does carry a line of wax polishes fitting in neatly with the need of keeping the surfaces of fine cabinets in prime condition, but that is largely incidental and more of a service to customers than a necessary staple of the business.

The principal radio lines with which the store started out into wartime were Philco, Zenith, Emerson, Motorola, Crosley, RCA Victor and General Electric, with a scattering of others. Service on all is still maintained.

Awaits Postwar

Blair Uber feels that while things go on as they are his position is satisfactory, and when production resumes he will be in position to welcome it. The first new models are almost sure to be duplicates of the ones he has in crates. If they come out at higher prices he will be able to choose between serving his customers at present lists if his overhead stays constant, or marking up any necessary part of the new list prices on his perfectly new merchandise, if costs require it. Should price cuts be necessary on his stock, he feels that he can well afford to make them. If television reaches the productive stage with a sudden burst of speed, he will be ready to sell that, too.

SCHOOL for his

Donaldson's of Kansas City Specializes in Electronic Maintenance. Staff Attends Classes Conducted by Owner

• Every Tuesday night you'll find the personnel of the Donaldson Radio & Electric Co., Kansas City, Mo., quietly seated in the wide driveway inside of the big building for another session of the "school" their boss has set up for them.

With eager interest, the staff waits for the "show" to begin so they can learn more about practical radio repair problems of the present, and watch the future of radio unfold before them on the blackboard and on the screen, via films furnished by manufacturers.

All 16 members of the staff attend the school, even the office girls. Do the girls like it? You bet, because it brings them closer to their jobs and sharpens their wits for the wide variety of customers' questions.

The school is one phase of postwar planning by C. W. Donaldson, the corporation's dynamic president. He purchased textbooks used in an army-navy training school for radio technicians. The classes are three hours long—two hours allocated to lecture and one hour for moving pictures. Next move of this enterprising radio-

man will be to set up a skeleton radio receiver board which can be taken apart and put back together by the class.

Three months old, the school is Donaldson's answer of one way to keep up with the trend. Come Victory, this radio technician intends to jump into large-scale repairing of intercommunication systems, all types of sound work, and slant his business toward repairing radio-controlled devices used in industrial plants.

Technician's Era

"The radio repair field is passing from the stage of screw drivers and pliers," Donaldson declared, "and moving into a highly technical phase where a radioman must keep step or lag behind and be in the same position as a blacksmith in an era of motor cars. One way to keep abreast is to educate your staff. We're no longer curbstome mechanics; we're professional, highly specialized experts."

There are two types of radioman, Donaldson noted. First, the man who is long on experience, but short

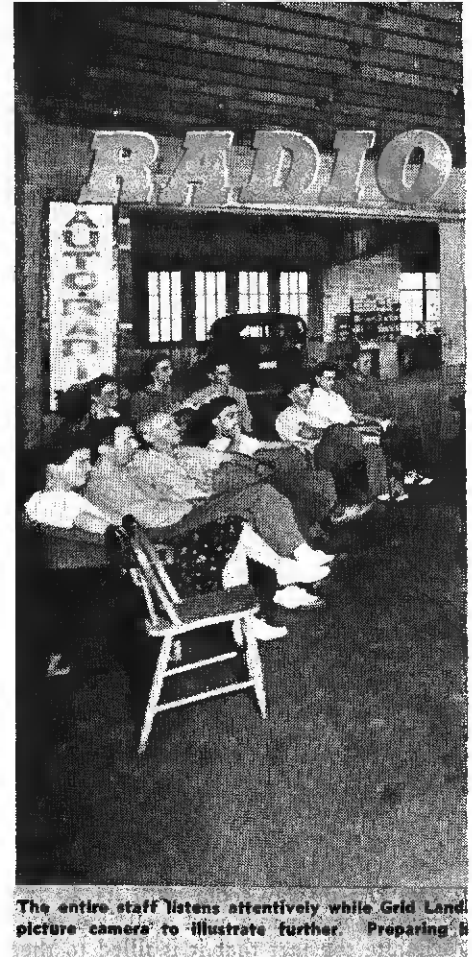

The entire staff listens attentively while Grid Land picture camera to illustrate further. Preparing

on fundamental training principles. And secondly, the youth who is just out of some training school, brimful of theory, but short on practice. The school helps both men.

In the past twenty years, this firm has been in practically every aspect of radio—from sales to repairs. But repair is the backbone of the company, with auto radio repair accounting for an easy 50% of the business.

"It is on maintenance that we have placed our major dependence," he said, "whether in the lean depression era, or the boom days of the present. Whether there's a shortage of merchandise and plenty of money, or vice versa, service makes a sturdy post on which to lean."

For a few years—1936 to 1942—the firm offered a refrigeration repair service, but this was abandoned when the entire staff in this section succumbed to the lush offers of war plant work.

Tomorrow's Plans

Besides the educational feature, Donaldson has some other pretty definite outlines for the future. The plant will undergo a complete overhauling, including a new cafeteria and recreation room for the employees, but one of Donaldson's favorite features in the pigeonhole in his desk marked "Postwar Plans" are

The firm specializes in auto radio repairs, and when Donaldson moved his two experts on major auto radio repairs into a section by themselves, production in this department increased 20%. Future plans include soundproof booths for his servicemen.



TECHNICIANS

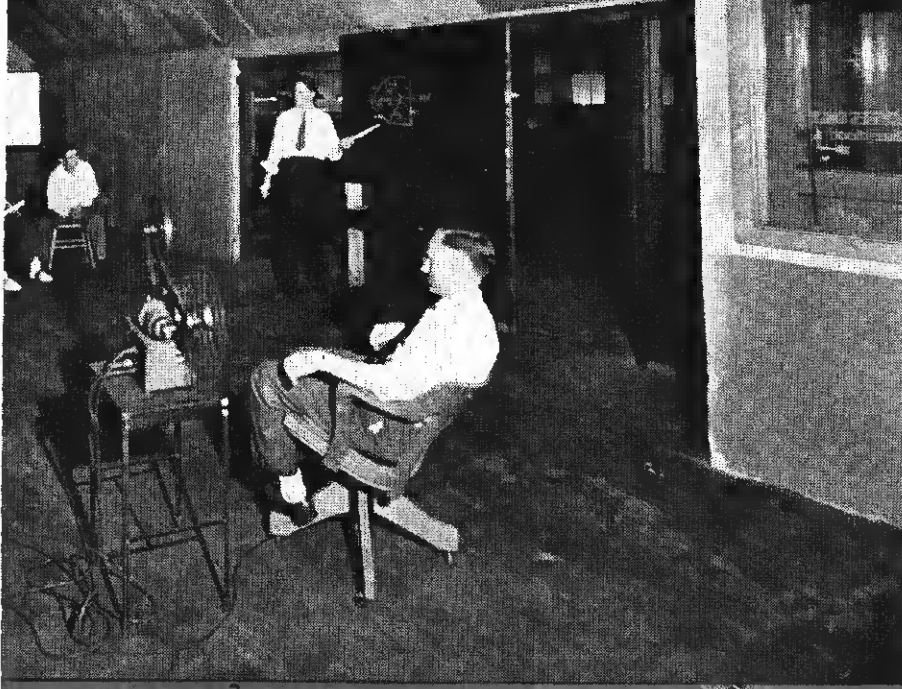

One of the employees, explains a problem at the board. "Boss" Donaldson operates the motion picture camera for the intricate electronic problems of the future is one phase of Donaldson's postwar planning.

sizes is the fact that it is necessary for radio servicemen to charge for work. The man who has a habit of saying to customers, "That's okay, forget it," when he does a job that takes more than a very few minutes, has the wrong attitude. *Do a good job, and charge for it*, is his theory.

Part of his success in building up a large clientele is in offering a gracious estimate service that allows the customer to approve the work or not, as he chooses, but the customer's green light must be received before work is begun.

Donaldson cooperates with many car dealers in the city on car radio repairs, and with these companies, simple but systematic records have proved invaluable.

(Continued on page 88)

the blueprints of the soundproof booths which will be built for his repairmen.

Since the firm will feature intercommunication repair work, as well as other electronic repair jobs, he feels that these soundproof booths, which will be air-conditioned, and large enough to accommodate two men, will prove highly advantageous.

Specialized Setup

"Eliminating interference steps up production. By simply moving my auto radio specialists into a room by themselves, 20% more work was turned out," Mr. Donaldson said.

The physical setup of this plant is ideal for a postwar expansion program. Recently the firm moved just off of a heavy-traffic boulevard so customers could use the drive-in facilities to a better advantage. 10,000 square feet of floor space includes a section for minor car radio repairs, one for major car radio repairs, one for house radios. Also a section for intercommunication systems work and similar jobs, a spacious parts department, and two offices. Cars drive in the front of the building and out the rear.

Business at this firm is 90% cash. Often, the firm makes minor repairs gratis, if the difficulty is, say, a faulty fuse. One point Donaldson empha-

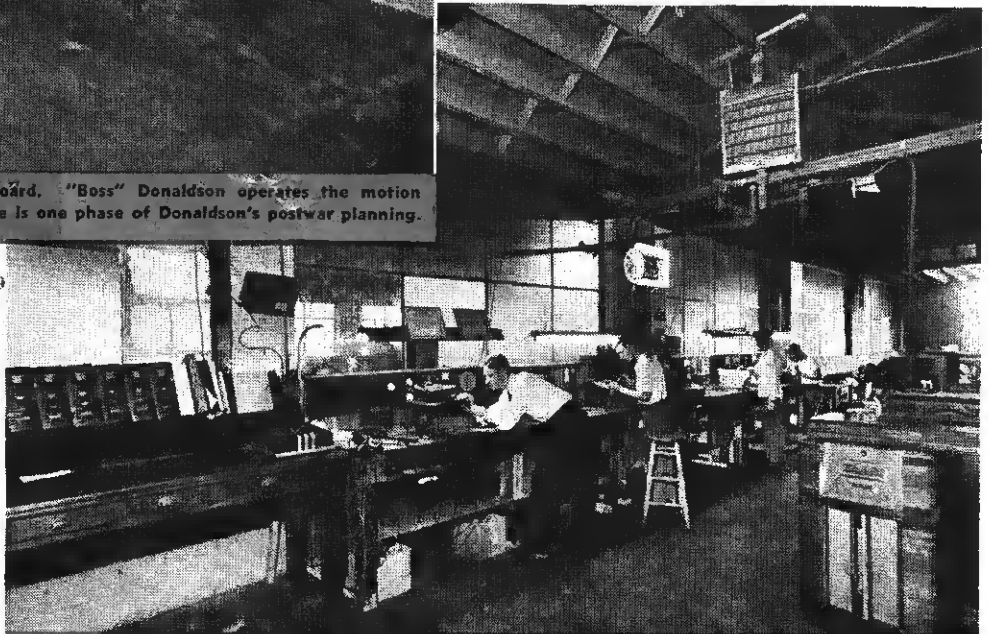

▲ Junior employees, who are given an opportunity to graduate into regular positions with the firm, have helped to solve Donaldson's current employment problems. This system has been so satisfactory that he intends to continue his apprentice and educational plan after the war.
▼ The section used for making minor auto radio repairs and installations has definite value.



Clark's

RADIO

SALES & SERVICE

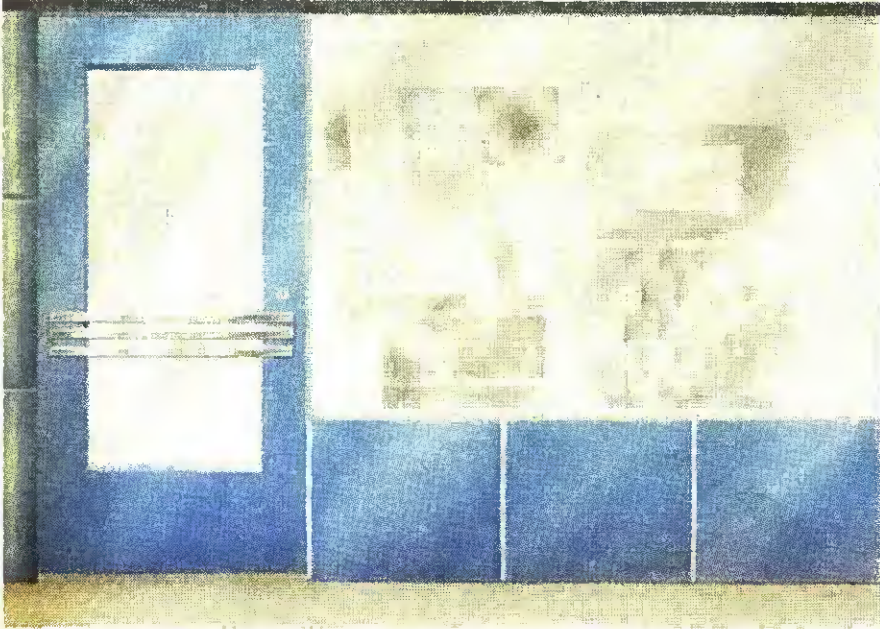

Put on a New FRONT

Good-looking storefronts are in use or being planned all over your town. Don't let your place of business fall behind the procession. *Make your radio store "the liveliest store in town!"*

Investigate construction facilities in your locality and improve on the front you now have. It isn't necessary to completely rebuild.

Shown here are visualizations of improvements of actual radio storefronts, as prepared by Charles F. Dreyer, Industrial Designer.

Whether you remodel modestly with just new surface panels and appliqué materials, or build anew, an improved storefront will result in increased attention from buyers—and sales!

↑ Bright paint your door. Add a modern hand bar. Use colorful tile or glass for a new bulkhead under your window and on sidewalls leading to the door. Make use of all available space overhead for a brilliant sign.

↓ Sharp corners are repelling, so curve-glass your windows where possible. "Bring the inside of your store outside" with a new all-glass door. Retrim with glass, tile, or metal.

SALES APPLIANCES-RADIO SERVICE

Radio, Television, Phonograph, SMITH'S Refrigerators, Washers, Appliances



Radio & Television

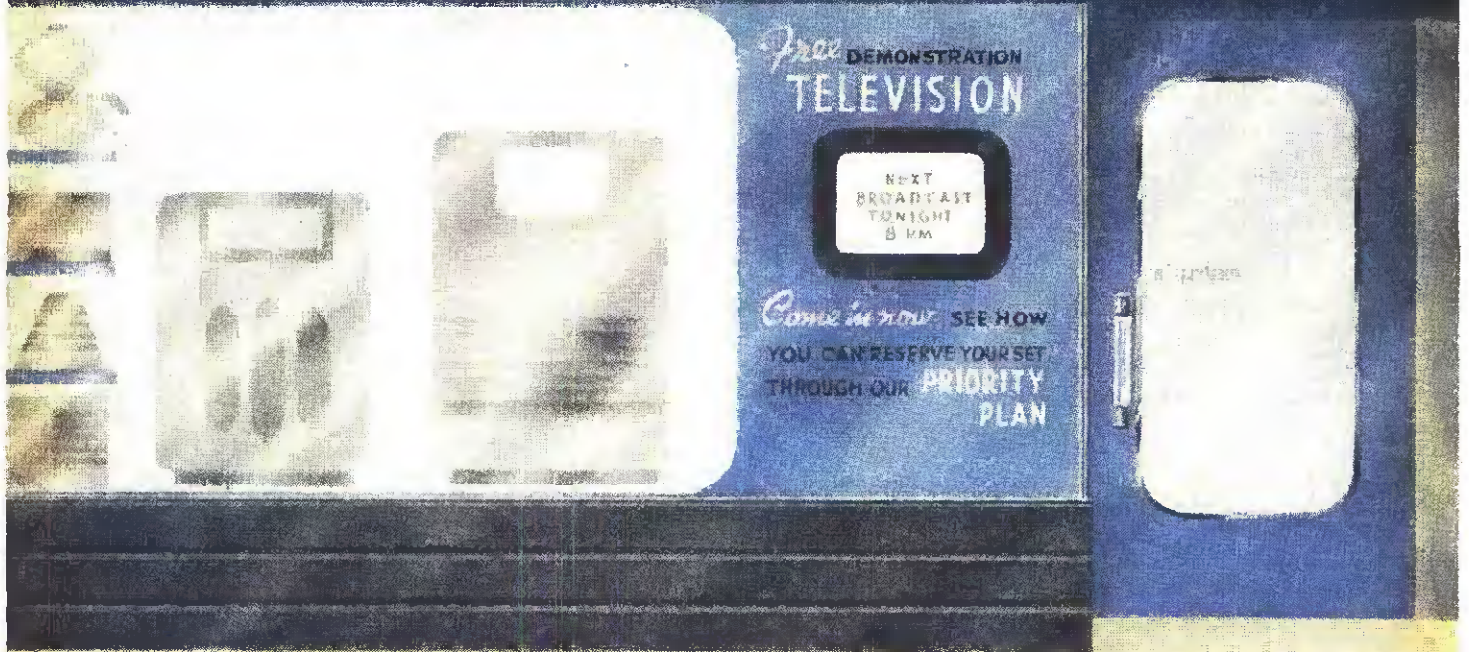

Lustrous structural glass under the window cleans easily, and its use on the entrance sidewalls gives a mirror effect which increases the apparent size of your front. Bold cutout lettering of wood or metal can be fastened to a sheet metal overhead panel which serves as an awning housing. Sell Television in a shadowbox window display of enamel tile-board, plywood, or fibre-board.



Are you building? Think of new display structural ideas. Long bands of metal trim "streamline" your front. Display your service department or display special merchandise behind large areas of plate glass on your second floor. Make your whole store interior a street display with plate-glass open-backed windows and fully transparent doors. Get the crowd near your door with a "Television Lobby" of colorful tile or glass.



Future Plans Spur Dealers

Radiomen work and plan now for postwar business. Maintain high standards

TUCSON, Ariz.—Edmund V. Roh, owner of Roh Radio Service, 523 N. 6th Ave., is one of many dealers who has completed a set of plans for expansion once materials are available. Roh intends to change his service shop, which now occupies all the store space, into a combination sales and service establishment, as soon as his jobber gives the signal that merchandise can be provided for him to sell. In the meantime, Roh is influencing his service customers to think of his store as their future buying center for radios. As another step in his carefully developed plan to get customers used to the idea that he will sell as well as repair sets, Roh arranges the radios he has already repaired, in an attractive display on the floor of his store. This usually creates comment, and Roh gets in a plug for his future store.

BROOKLYN, N. Y.—The growth of the Lincoln Radio Co., Inc., at 552 Fifth Ave., since 1928 is a characteristic example of what is going to happen to many other appliance stores in the next postwar period. Starting off in a small 10' x 15' store at a time when radios were just beginning to arrive, Lincoln Radio now occupies two large floors of a spacious building.

Before the war, the upper floor was devoted entirely to the sale of radios, refrigerators, washers, stoves, oil burners and electrical appliances. A balcony, in the rear, was equipped for demonstrating television sets. The lower floor carried a complete line of men's clothing. Since the war, however, the radio department is located downstairs and the upper story carries a substitute line of women's clothing plus a complete line of costume jewelry.

A separate entrance to the radio department was built in on one side of the building about a year ago. Re-

pairs are made as quickly as possible, but since only one radioman is employed on the premises, old customers, and those with only one radio, receive preferred service. The time usually required to repair a radio is from ten days to two weeks.

Max Zimand, manager, makes it a policy to keep in touch with former customers through local advertising.

ST. PAUL, Minn.—“Keep Your Radio Working,” is the motto of the Ace Radio Co., managed by J. G. Heywood. Booklets, signs, and newspaper advertising all serve to publicize the same advice, and play up the value of radio in keeping in touch with world events. No merchandise is sold in the shop, and Heywood concentrates all his activities on the repair of radios. Heywood picks up and delivers when necessary, and usually manages to return sets on the promised dates. He finds these simple procedures go a long way in creating good-will.

J. G. Heywood, at work in his repair shop.



PRICE, Utah—Rulon D. Blackburn's radio repair shop is one of the busiest in the southeastern Utah territory, for Blackburn's Radio Service is the only repair shop in this trading area. Mr. Blackburn, a newcomer to Price, formerly handled radio repairs in Salt Lake City. He reports that since coming to this new location business has been very good.

WINONA, Minn.—Making repairs for neighboring farmers is the specialty of R. L. Cone's Hardware shop. Efficient and speedy service is maintained by Cone's staff of three men, all over 60 years of age. The staff specializes in the repair of washing machines, vacuum cleaners, milking machines, cream separators, and other small appliances. The firm has a delivery and pickup service for the farm trade, although many farmers bring in their own repairs when they come to town. K. McQueen, owner of the store, is looking forward to a prosperous appliance business, with the trade he has built up through service, in the postwar period.

TOLEDO, Ohio—Ed's Appliance Service, 1623 Broadway, is located in a busy neighborhood near the railroad. Ed Shaffer, proprietor, has learned through years of experience, that what his customers value most is an expert repair job, quickly done. Washers, electric ironers, vacuum cleaners, roasters, mixing machines, radios, and kindred appliance repairs are his specialty. Ed believes in the value of good advertising, and directs a lot of his copy toward housewives. As a result, he and his helpers have been swamped with work.

ROCHESTER, N. Y.—To eliminate the headache of answering phones, handling customers, and trying to repair sets all at the same time, the

On, Across the Nation

good service, and initiate unique systems to facilitate customer convenience.

Davis Service has put into effect a system reserving certain hours of the day for each task. They have a fixed time between 2-4 p.m. and 7-9 p.m. when customers may visit the shop to leave or pick up radios. At all other hours it is closed to the public. Telephone calls are not answered during the four hours the store is open, but customers may phone at other times. In times of help shortages like these, this enables servicemen to concentrate on their repairs, without distractions, and eliminates the necessity of trying out "alternate day" proposals.

MARTINSBURG, W. Va.—More and more jewelry shops have been finding it to their advantage to carry radios. The Royal Jewelers, 120 N. Queen St., has floor models as well as portables of many different makes. Radios are given a conspicuous place in the store, and attractively displayed. Mrs. Donald O'Rourke, manager, is very optimistic about the future, and once more sets are available, the Royal Jewelers are planning to expand and devote a greater volume of their business to the sale of radios.

CORONA, N. Y.—M. P. Jeantet, proprietor for 9 years of the WMPJ radio shop, 3761—103rd St., has purchased a building a block away from his present location in accordance with his postwar plans. The building is 25 x 100 ft. Mr. Jeantet intends to put an air-conditioned shop in the basement, display a recording studio in the showroom, and feature a miniature television demonstration theatre. A large line of radios and the other appliances will be carried, too. At present, in addition to servicing many radios and appliances, Jeantet does a big business in maintaining sound equipment for theatres and other groups.

LIBERTYVILLE, Ill.—A. Herschberger, 334 Milwaukee Ave., is another radio service shop proprietor, who has found the record department becoming the core of his business since its installation 2 years ago. The record club, composed of 400 buying members, contributes a steady flow of profit, in addition to the occasional record buyers. Record club members receive one free record with the purchase of a dozen discs. The price range from which selections may be chosen depends on the price paid for seven or more of the discs. Seven records purchased at 50c each entitles members to make a choice from 50c group. Price categories eliminate unnecessary confusion.

WASHINGTON, D. C.—Courtesy is the keynote of the Chevy-Chase Radio & Electric Co.'s postwar planning. Located at 4451 Connecticut Ave., N.W., a residential neighborhood that houses many war workers, Chevy-Chase's specialty in service has been yielding a trade that averages 240 to 400 sets monthly. They have inaugurated a popular courtesy card service. If a serviceman calls and finds no one at home, he leaves a card telling the customer of his having been there, and asking that he call them again. Their unusual courtesy policy, accompanied by efficient service, is building Chevy-Chase's reputation as a popular buying center for the future.



MT. VERNON, N. Y.—J. M. Fernandez, whose corner store is at 15 Prospect Ave., a busy intersection, interests the passers-by as he repairs sets. It's good advertising, too, and show-window servicing solved the problem of what to do with a big showroom formerly displaying a complete line of radios and appliances. An additional repair shop is in the basement.

POSTWAR TRENDS in

Jobbers Confronted With Multitude of Problems as They Prepare for Future Merchandising

● With full or partial resumption of the manufacture of radio electronic and electrical equipment for the civilian consumer looming as a possibility in the near future, distributors are studying trends and problems in order to participate actively and efficiently in the coming upswing.

There are a number of timely and pertinent questions distributors in the radio-appliance field are asking themselves. They are seeking answers to some or all of the questions here listed.

Commenting on Question No. 1, most distributors agree that, postwar, there will be new forms of merchandising to compete with. There will be the streamlined "chains"—doubtless operating more efficiently than ever. One of the country's leading executives in the field of wholesaling of radios and appliances, states that he feels certain the independent distributor will continue to sell the bulk of this business for a long time to come. He has no fears about the jobber's future.

The "chains," according to best merchandising information, already account for as much as 20% of retail consumer durable-goods business throughout the country, and no one will deny that the "chains," "co-operatives" and other selling groups will get a sizeable share of the future business. The independent distributor, is, however, aware of the threats these groups present, and expects to be able to withstand their onslaughts by employing modern, speeded-up distribution techniques, and as many of the methods used by his new competitors, as he feels are practicable.

Margins Up or Down?

There is considerable difference of opinion on the question of discounts, mentioned in No. 2. One leading distributor states as his unequivocal belief that profit margins will be sharply lowered. Others believe they will remain about the same as they are now. One jobber's opinion is that discounts will be definitely shorter immediately after civilian production is

resumed, but that they will be increased as production commences to catch up with the public demand.

Question No. 3 is related to Question No. 2 in that answers sought must be based upon speculation. How surpluses will affect selling markets, it is agreed, will depend upon the following factors:

- a. How large the surplus stocks to be released are.
- b. How adaptable the surplus materials are to the consumer demand.

Many of the problems confronting distributors are being threshed out at the present time. There is a feverish activity in the field. Manufacturers are circulating throughout the trading areas appointing wholesalers, and the latter are seeking to increase their dealer accounts. It is interesting to note that with virtually no merchandise available now, a number of new distributing firms are springing up all over the country, so, in answer to Question No. 4, it seems definitely assured that there will be many new wholesale outlets in operation when the "go" signal is given.

150 Customers Each

Doubtless there will be a shuffling about of distributors' customers, but one distributor, who travels almost continuously throughout the country, seems to feel that the present general average of about 150 customers per distributor will be maintained postwar.

Will distributors, heretofore handling parts exclusively, sell radio sets, etc., when production is resumed? Right now the trend seems to be strongly slanted toward diversification of wholesale lines, and it appears certain that a considerable number of distributors will make changes in their present lines, with many parts distributors handling sets and home appliances.

Possible government regulations are closely associated with the future delivery situation, as distributors view it.

Since factors governing many of these problems depend upon future conditions and changes, one man's guess is as good as another. If, for instance, after manufacture has been authorized for the production of radio and home appliances, government regulations continue to be imposed, such as ceiling prices, terms, etc., the business operation would be different than it would if all such regulations were to be lifted.

Even the delivery of merchandise from the distributor to his customers would be seriously affected if the gasoline shortage continues during the period radios and appliances are again manufactured for the home.

View Video Picture

Distributors are evincing great interest in television. Naturally, they are familiar with electronics sufficiently to realize that certain new techniques relating to demonstration and maintenance will have to be employed, and most of them who are situated where their dealer accounts can sell reception to the consumer, have already made plans to handle what they predict will be a land-office video business.

The question of sales force reorganization is occupying much attention on the part of the distributor now. There are changes in personnel being made daily on the distribution front, and it is noteworthy that more and more wholesale salesmen are calling on dealers throughout the country.

Talks with distributors disclose no particular alarm about the possibility of an increased trend toward bypassing the wholesaler on the part of manufacturers in selling their merchandise direct to the dealer. Most seem to feel that there will be no increase in the direct to dealer selling plan, but that about the same number of makers will continue to sell deluxe sets, not in mass production, to dealers postwar.

In discussing Questions No. 10 and No. 12, distributors feel that the immediate period after manufacture is

RADIO DISTRIBUTION

resumed, will see chiefly cash-buying on the part of the consumer, to be followed later by installment purchasing.

On the question of price-cutting, it appears certain, say distributors, that there is a definite trend toward more and more states adopting fair-trade laws, and such legislation is heartily welcomed by both distributor and dealer. At a recent meeting in New York, over a thousand dealers stood up and cheered when a distributor stated that all his merchandise would be sold under the state's fair trade act.

One of the problems the distributor selling parts and major appliances is

confronted with is how to split up the merchandise so that his salesmen will push the small items as well as the large ones, as mentioned in Question No. 13.

Substitute Items

The size of the distributor organization, the size of the territory and the number of dealer accounts governs to a great extent the number of lines a salesman should offer his customers. Since it is natural for a salesman to bend greater effort toward selling four hundred dollar teletests, for example, than a few variable condensers, many wholesale organizations believe that the answer lies in hiring separate salesmen for

the separate lines carried by the firm.

Distributors have been giving considerable thought to Question No. 14, and many state they will definitely retain in their postwar lines certain substitute items, extraneous to the radio business, which have proven good sellers during the merchandise shortage period.

In the substitute item line as far as the postwar period is concerned, the distributors, and the dealers too, will not have to gamble. They have tried out substitute merchandise on the consumer front, and their ledgers are reliable barometers to consult in making decisions as to what lines to retain in the future.

HAVE YOU THE ANSWERS TO THESE QUESTIONS?

Fourteen Points for Postwar Planning and Selling

1. **What new forms of distribution will challenge the present types postwar?**
2. **Will discounts be shorter or longer than they were previous to this war?**
3. **How will surpluses, known to exist now in certain stocks, affect markets if large quantities are released?**
4. **With a number of new manufacturers entering the home radio-appliance fields, how many new distributor organizations will be set up in competition with existing ones?**
5. **Will distributors, heretofore handling parts exclusively, sell radio sets, etc., postwar?**
6. **What new shipping and delivery techniques will be employed postwar?**
7. **Will existing or new government regulations affecting merchandise distribution be in force?**
8. **With television promising great things, how shall the distributor set himself up to properly sell and service it?**
9. **How shall the distributor set up a new sales force, or reorganize his present one to increase coverage and volume?**
10. **Is there a trend on the part of some manufacturers to bypass the independent distributor in the setting up of factory branches and/or selling direct to dealers?**
11. **In the financing of his own business and the business of his customers, does the distributor visualize improved postwar conditions and facilities?**
12. **Is there a nationwide trend toward legislation aimed to prevent reprehensible price-cutting, which would serve to stabilize and enhance the distribution business?**
13. **Will distributors who plan to sell both radio parts and home appliances be able to employ the same salesmen to sell all the lines advantageously? Or should salesmen be grouped to sell certain items exclusively?**
14. **After the war, how many "substitute items," now being sold, will be retained by distributors as regular selling items?**

CENTRALIZED

Progressive Radio-Televi and Installs Super Sound

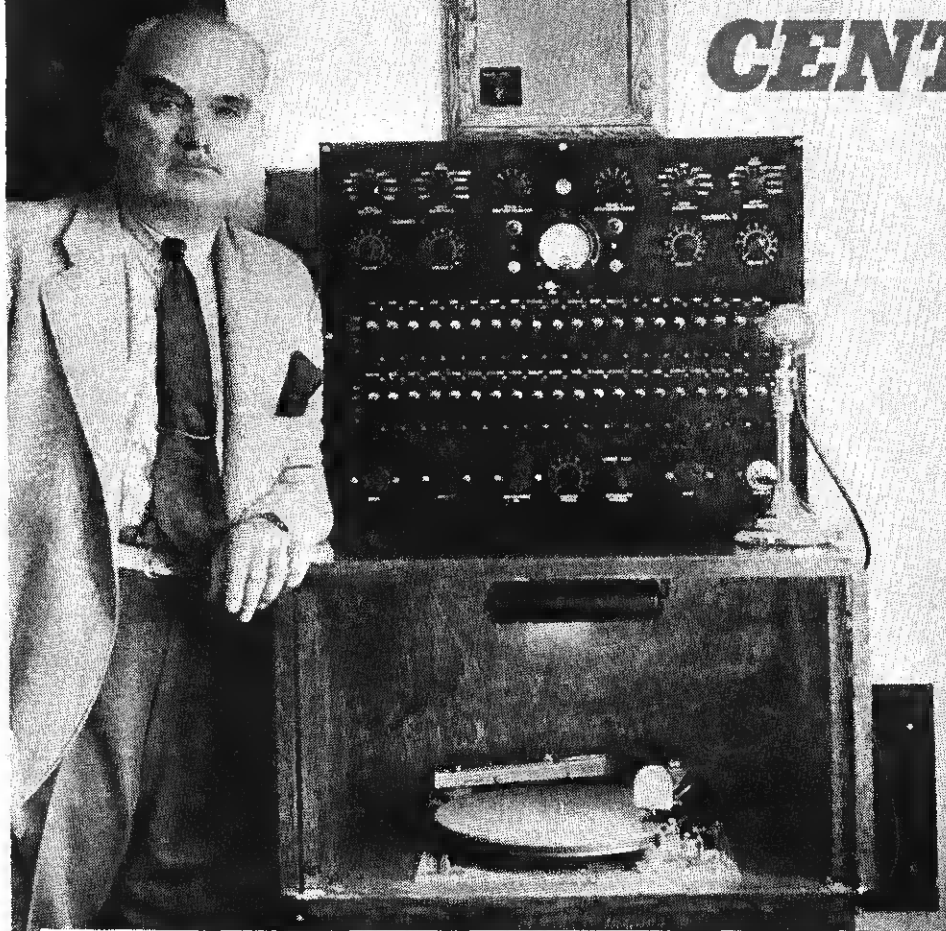

• The radio, public address and two-way communication system in the Katonah High School, Katonah, N. Y., was started when R. J. Doyle, owner of Doyle's Mount Kisco Radio Shop, Inc., furnished the architects with riser diagrams which were incorporated in the plans of the High School.

Very little effort was expended in selling the idea of incorporating in their plans for the school the following system, due to the fact that members of the Board of Education were all progressive men and women who could visualize the advantages derived from a system of this type.

The necessary conduit, speaker boxes, remote control and microphone

Left above—Mr. R. J. Doyle in the control panel which he designed for the Katonah, N. Y., High School sound system. Below—The block layout of the school radio and sound equipment.

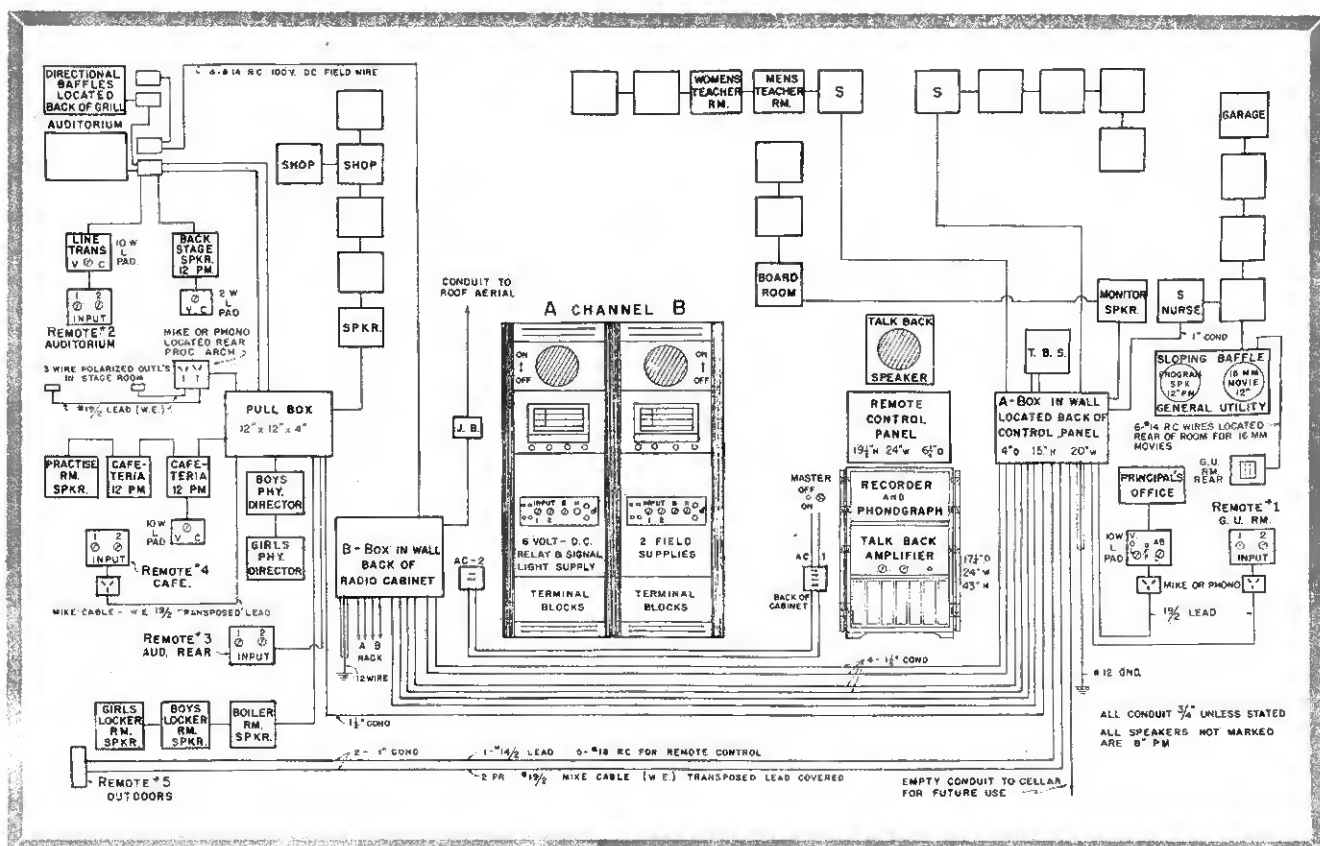

RADIO-SOUND SYSTEM

m-Appliance Dealer Plans Layout in High School

outlets were included in the electrical contract. Mr. Doyle carefully checked the installation of the above-mentioned material as to conduit sizes and location of the various boxes until completion. Upon completion of the building, the work of installing the system was started.

One very important consideration in an installation of this kind is the type and quality of wire and cable used. Cheap wire will give no end of trouble. In addition, power losses, and what is more important, the frequency losses will impair the overall quality of the system. In this installation, 8000 feet of RCA-MI 38 audio frequency cable was used for all speakers with the exception of the wire going outdoors to the stadium speakers. One pair of #14 lead covered wires was used here. All microphone wires or cables were 19/2 transposed lead covered cable, W.E. commercial type. Some 6000 feet of remote control wire was #18 rubber covered. About 3000 feet of #16 rubber covered was used for relay wiring, station selector wiring and various other connections. One thousand feet of #14 RC wire was used for the two DC field runs to the auditorium.

Features of System

"While on the subject of wiring, it is important to call attention to bonding or grounding all cables," says Mr. Doyle. "All shielded cables terminating in the radio room were grounded to a common point with a #12 wire going to a cold water pipe in the cellar. Every shielded cable going to, or away from the control panel was grounded. This meant that all shielded wires between radio room and control panel are grounded. On long runs through conduit, never use soap of any kind. Should a pipe sweat, there will be a chemical action, which will injure the wire. Use a cheap grade of talcum powder when necessary to ease the pull on the wire. For economical reasons always run long runs first. If the conduit is laid out correctly, you will have very few

pull boxes, for each speaker box serves as a pull box."

The Katonah High School system was planned to:

- (1) Provide 2—25-35 watt amplifiers with gain of at least 110DB from a 250 ohm input.
 - (2) Provide 2 radio receivers with electric motor tuning.
 - (3) Provide facilities for a two-way loud speaking communication between class rooms and clerks' office where control panel is located.
 - (4) Provide for remote control of basic equipment located in radio room from control board located in clerks' office.
 - (5) Provision for remote control of local inputs in auditorium, both from stage and rear of auditorium, cafeteria, general utility room and outdoors.
 - (6) Provide facilities for microphone and phonograph from control panel in clerks' office, also in auditorium, cafeteria, general utility room and outdoors.
 - (7) Provide loud speakers in all rooms.
 - (8) Provide switching facilities on control panel in clerks' office for individual control of each loud
- (Continued on page 120)

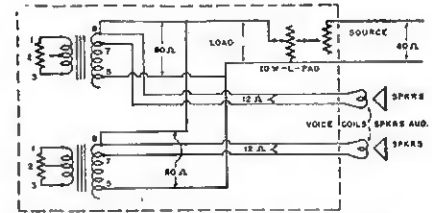

Speaker connections to transformers. Volume is equalized by adjusting taps on windings.

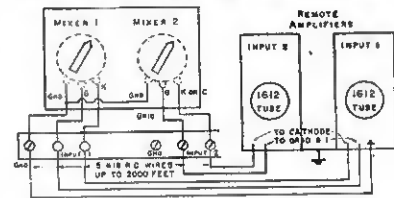

Remote control wiring between remote control points and channel amplifiers.

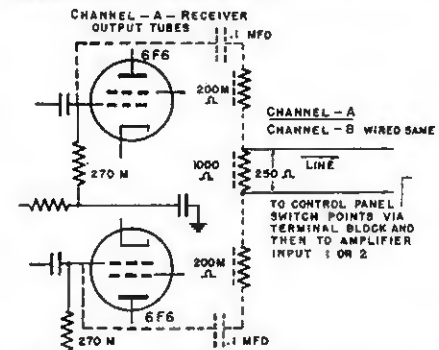

Output circuit of receivers for input to amplifiers.

Typical speaker installation in library of Katonah High School. All classroom speakers are flush wall mounted with matching grille frames.



RECORDS WILL

Discs, Today's Mainstay, Tomorrow's Traffic Builder.



symphonies • concerts • tone poems •

chamber

music •

overtures •

dinner music •

popular

albums • complete

Above left, president Lohman of Haynes-Griffin. Next right is record dept. manager, Miss Kraushaar, who brought discs from a "corner" to the center of the floor.

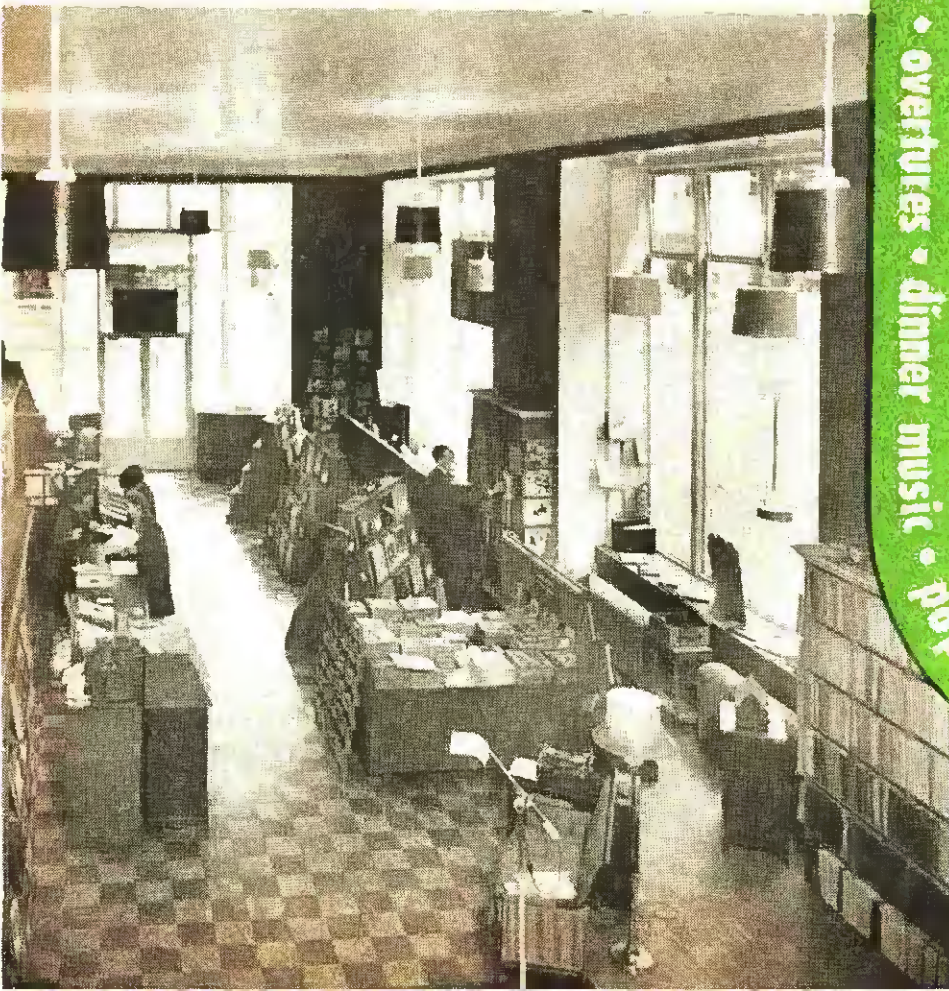

• An attitude of helpfulness to the customer is a merchandising jewel today, claims George P. Lohman, president of Haynes-Griffin, one of New York's leading radio-music stores. Right now the customer is on the toughest spot he has ever been on, and today's backlog of good will for the retailer will mean tomorrow's tops in sales.

Caught in a net of merchandise shortages, George Lohman has done one of the finest selling jobs imaginable in these restricted times. First of all, he is ready right now for M-Day, the day when merchandise will again be available for the public's purchase. His new location is already chosen and settled into. Catering to the carriage trade was not enough for him. He is going to hold that high-priced market but intends to add to that business by bringing in the everyday street traffic, as well.

Smart Arrangement

First in the category of selling facts this retailer has made use of is his choice of store arrangement and the full advantage of window display. There is a psychology about windows. Size has a lot to do with it. Strangers to a store avoid it if they have no idea what to expect when they get inside. Rather than bear the embarrassment of refusing purchase, they would stay out of the shop altogether. If, on the other hand, they can see into the store before they enter, they have more confidence. A customer is really a timid soul, nine times out of ten, believe it or not! Large, spacious windows permit the prospective customer to see inside, note the type of customer already in, see if there is anything he wants. It takes all the "fear of feeling stranded in a

strange place" out of the situation.

Inside the store a perfect plan for arrangement has been carried out.

(Continued on page 115)

SELL APPLIANCES

New York Radio-Music Store Readies Franchises in Major Appliances



Pictures on these 2 pages show strategic floor arrangement of the Haynes-Griffin store. Disc display divisions are clearly marked.



operas • latin american music • russian music • readings • folk songs





Ginger Rogers as Alice in Decca's album 376 appeals to children and grown-ups alike.

● Of equal appeal to adults and children alike is Decca's new album, "Alice in Wonderland," No. 376, with Ginger Rogers starring in this song and story continuity. A galaxy of interesting people go into the making of this album, not the least of whom is composer and director Victor Young. The adaptation of Lewis Carroll's famous fairy tale is done by George Wells, and is a success beyond criticism by the most exacting champions of this old familiar, charming and whimsical story. Told for children, its delightful satire is of special interest to grown-ups, as well.

Posters promoting this album are blown up to 30" x 40". Counter

cards and newspaper ads for dealers to run in their local papers are available. The album cover is designed and drawn by Walt Disney in his best hobgoblin manner. Excellent for Christmas sales, this group of records will be entertainment extraordinary for children and their elders alike.

Further Decca releases include Dottie Lamour's "Hawaiian Hospitality" album, No. 371. True to its promise, Decca presents this album on popular demand in attractive bright yellow folder, which adds to the display value of any window. Counter cards and 10" x 20" streamers in four colors are to be had for the asking.

Quite beautiful in its rendition is the pressing of "Warsaw Concerto," Decca disc 29150, recorded by the Philharmonic Orchestra of Los Angeles, under the direction of Alfred Wallenstein.

Timely in its appearance is Decca album A-377, "Liberté, Egalité, Fraternité," which consists of 10 parts. Charles Boyer reads in French the famous writings of outstanding French patriots, authors and philosophers in France's past and present. English translation in booklet form accompanies the set. Voltaire, Rousseau, Lafayette and DeGaulle are a few of the names in this unique album of dramatic reading.

Book and Album Duo

Columbia also offers exceptional material for Christmas sales for children. Their album set No. X-250, "Instruments of the Orchestra," is instructive and can be played in conjunction with Syd Skolsky's new book, "Evenings With Music." Written to increase understanding of music among parents and their children, and to improve habits of radio listening, this book and its accompanying album is really an excellent idea for

Columbia's set X-250 teaches both children and parents instruments in the orchestra and suggests further study.

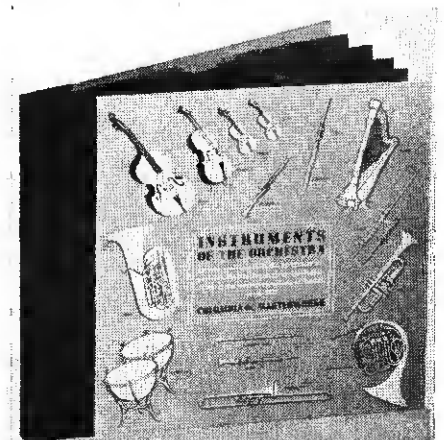

children's record library starters.

A remarkably interesting idea, this promotion of music appreciation, through book and records, offers the dealer endless opportunity to sell more and more of the classics.

Classics for Students

Equally interesting along these same lines is the promotion of the classics by the new NBC program, "Music in American Cities," which is scheduled to start in the middle of October. The series will introduce the contributions to American music originating in the various population centers. A supplementary handbook is available to those wishing to understand and follow more closely this course in music, and should be especially helpful to dealers. Address the National Broadcasting Co., 30 Rockefeller Plaza, New York 20, N. Y. The entire idea presents tremendous display value in ideas for windows and should offer extended possibilities for record library sales.

Victor has readied a number of children's records in album form for the Christmas gift season. These include famous folk lore and song, among them the familiar "Rumpelstiltskin" nursery rhymes and a wide variety of gift material for children of all ages.

Populars Plentiful

October 1st found Capitol with many gay releases for holiday trade. Johnny Mercer's latest, No. 164, is "Duration Blues" backed by "Sam's Got Him." Jo Stafford and the Pied Pipers also come up with "I Don't Know About You," with flipover "Tumbling Tumbleweeds." And, finally, as foretold, Jerry Colonna has pressed "Can't You Hear Me Calling, Caroline?" and "I Hate Music," No. 173. This has plenty of entertainment value, and displays should convey the fact that Colonna is really on the discs at last.

Another Capitol release for this

month which should pile up the sales is their Album A-8, King Cole Trio rendering 8 selections of the really old favorites, the kind that get under

your skin for all time. These include "Sweet Lorraine," "Embraceable You" and "The Man I Love," to name a few.

Victor's colorful array of children's albums has sales value in covers designed for young folks' delight.





Radio repair and parts dealers "go shopping" at the Commonwealth Sales Corp., Richmond, Va., and enjoy browsing around and waiting on themselves.

New Plan Ups Sales

Jobber Inaugurates Super-Market Plan to Facilitate Service to Its Dealers. Find Cash Parts Sales Increase Up to 300%

• As a result of opening its new super-market parts store, Commonwealth Sales Corporation, Richmond, Va., distributors, located at 1601 Summit Ave., is enjoying increased sales.

Commenting on the new self-service operation, Stanley O. Guillory, assistant sales manager, says: "We had our three-day grand opening August 23 through August 25, inclusive, and since find that we have increased our cash parts sales by better than 300% over the same period of a year ago, and an over all comparison in 1943 and 1944 of an increase of 217%."

For Dealers Only

The self-service department is operated exclusively for repairers and parts dealers, and the operators of the plan here are so well pleased that an official declares that "we are definitely going to keep this type operation post-war and as long as something better is not shown us. We have tried all other types of parts departments before and nothing has compared with this one."

One of the chief reasons for the popularity of this self-service plan, according to those distributors who have put it into effect, is the fact that dealers are thoroughly familiar with the equipment they come to purchase.

They are able to wait on themselves as quickly as any distributor's clerk could do, and in addition, being allowed to browse around, they frequently see other items they need which they had not included in their shopping list.

As a result of its participation in the self-service plan now being used by many Philco distributors throughout the country, Commonwealth has received valuable newspaper publicity. The "Richmond Times-Dispatch" ran a four-column illustration of the store's interior, captioned as follows:

"SUPER-MARKET FOR PHILCO PARTS — The Commonwealth Sales Corporation, distributors for Philco Radios and radio parts, has introduced an interesting innovation to speed up service to their dealers. It is designed to operate on the super-market idea which has been so popular and successful in retail food distribution.

Approved Unanimously

"The self-service plan was introduced to the Philco service and parts dealers from Virginia and North Carolina who were in Richmond for a three-day Philco convention. The dealers were given an opportunity to 'try out' this advanced merchandising idea at that time.

"The approval of those present was unanimous and the dealers voiced their pleasure at the inauguration of the plan.

"The new store is located in the Philco Building at 1601 Summit Avenue, and announcement is made that large parts stocks have been received from Philco, and they are now prepared to give their dealers a greatly improved service."

Tags Describe Items

Items offered for sale are tagged with complete descriptions, and since, as stated before, the purchaser is as familiar with the items as is the distributor and his clerks, much time is saved.

The radioman customer is furnished a shopping bag and he travels the rounds of the attractive parts bins making his own selections. This eliminates the possibility of mistakes in giving orders to clerks, and also permits the display and increases the sales of close-out items, which are offered at attractively reduced prices.

The officers of the Commonwealth Sales Corporation are as follows: James T. Little, president; E. Graham Flanagan, secretary and treasurer; Roy M. Campbell, operating manager and Stanley O. Guillory, assistant sales manager.

WATCH
for the
BREAK!

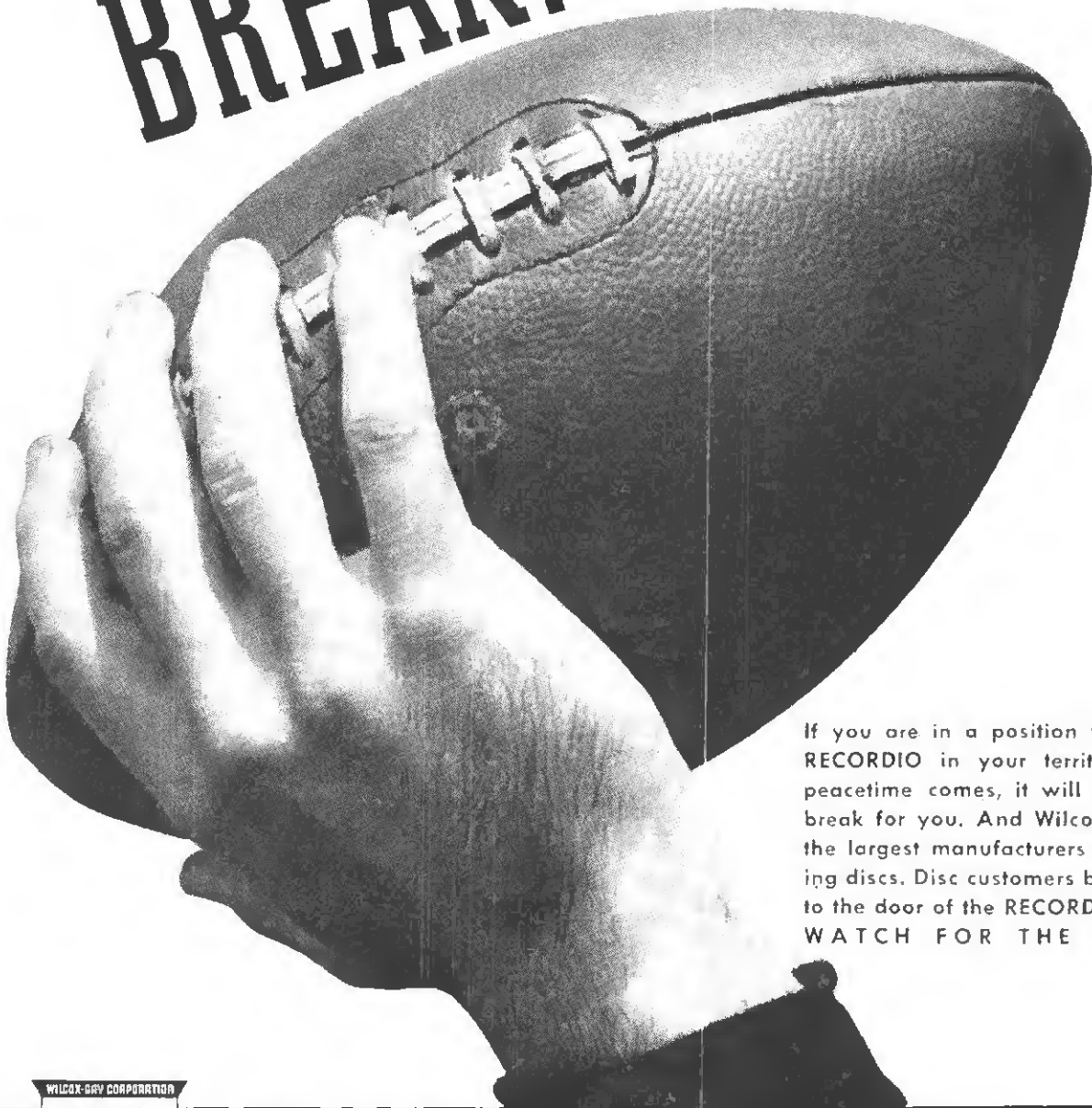

If you are in a position to sell the RECORDIO in your territory when peacetime comes, it will be a real break for you. And Wilcox-Gay are the largest manufacturers of recording discs. Disc customers beat a path to the door of the RECORDIO dealer. WATCH FOR THE BREAK!



WILCOX-GAY CORPORATION

CHARLOTTE, MICHIGAN

Manufacturers of the Recordio, Famous Home Recording-Radio-Phonograph Combination

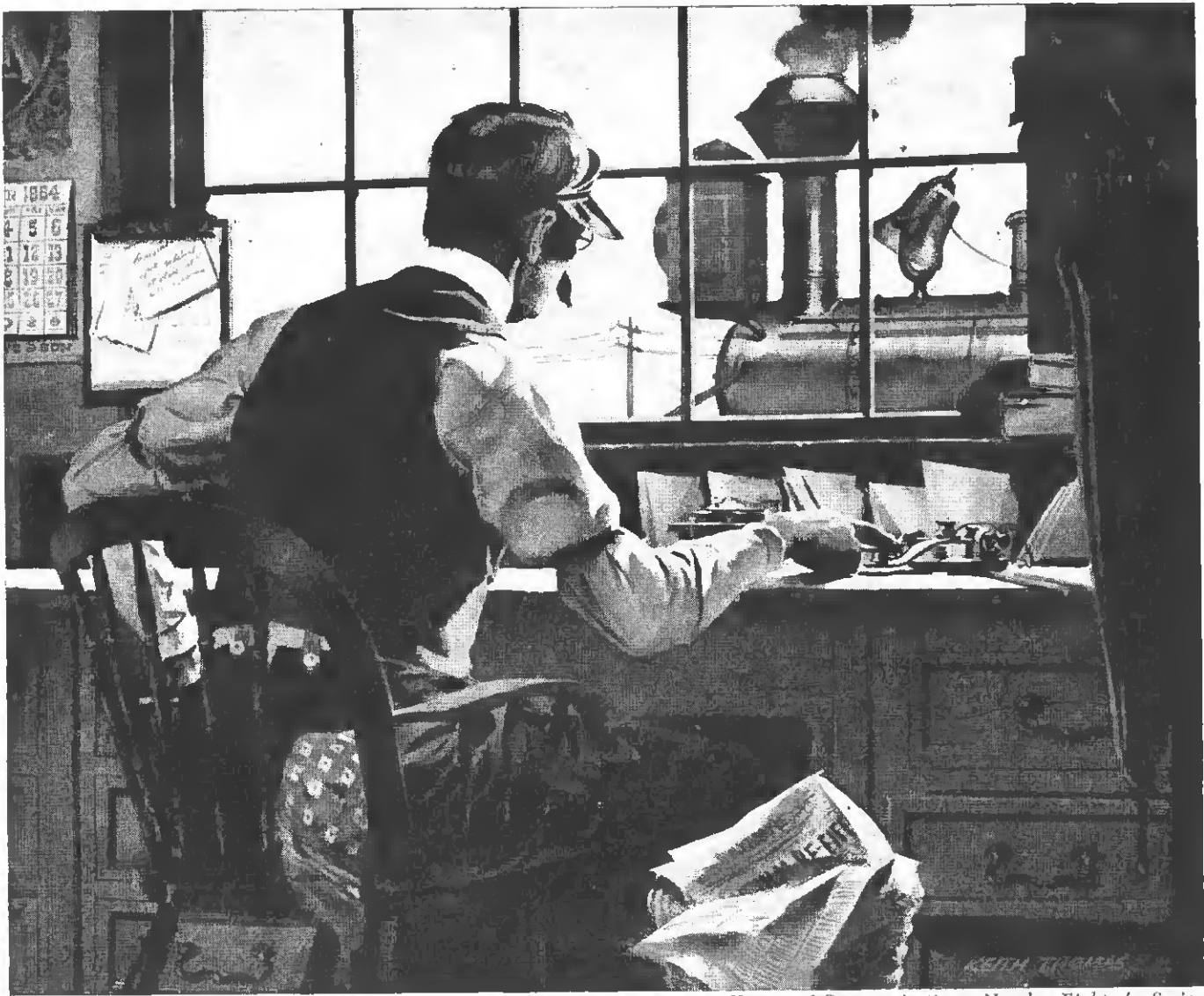

History of Communications. Number Eight of a Series

EARLY RAILROAD COMMUNICATIONS BY TELEGRAPH



Communication by telegraph was probably one of the first of the electronic arts which met with commercial success in America. Of constant interest to every boy in a small town, the telegrapher down at the depot was a hero — a man of great science. With the advent of faster locomotives, telegraphy was a speedy method of traffic control.

Today, and for the postwar period, the picture will include electronic voice communications for the streamlined trains which travel one hundred miles per hour. There must be a more flexible control via electronics, plus the added possibility of passenger luxury in radio telephones. Universal stands ready as an electronic manufacturer to serve in the era of applied electronics.

< Model 1700-UB, illustrated at left, is but one of several military type microphones now available to priority users through local radio jobbers.

UNIVERSAL MICROPHONE COMPANY
INGLEWOOD, CALIFORNIA



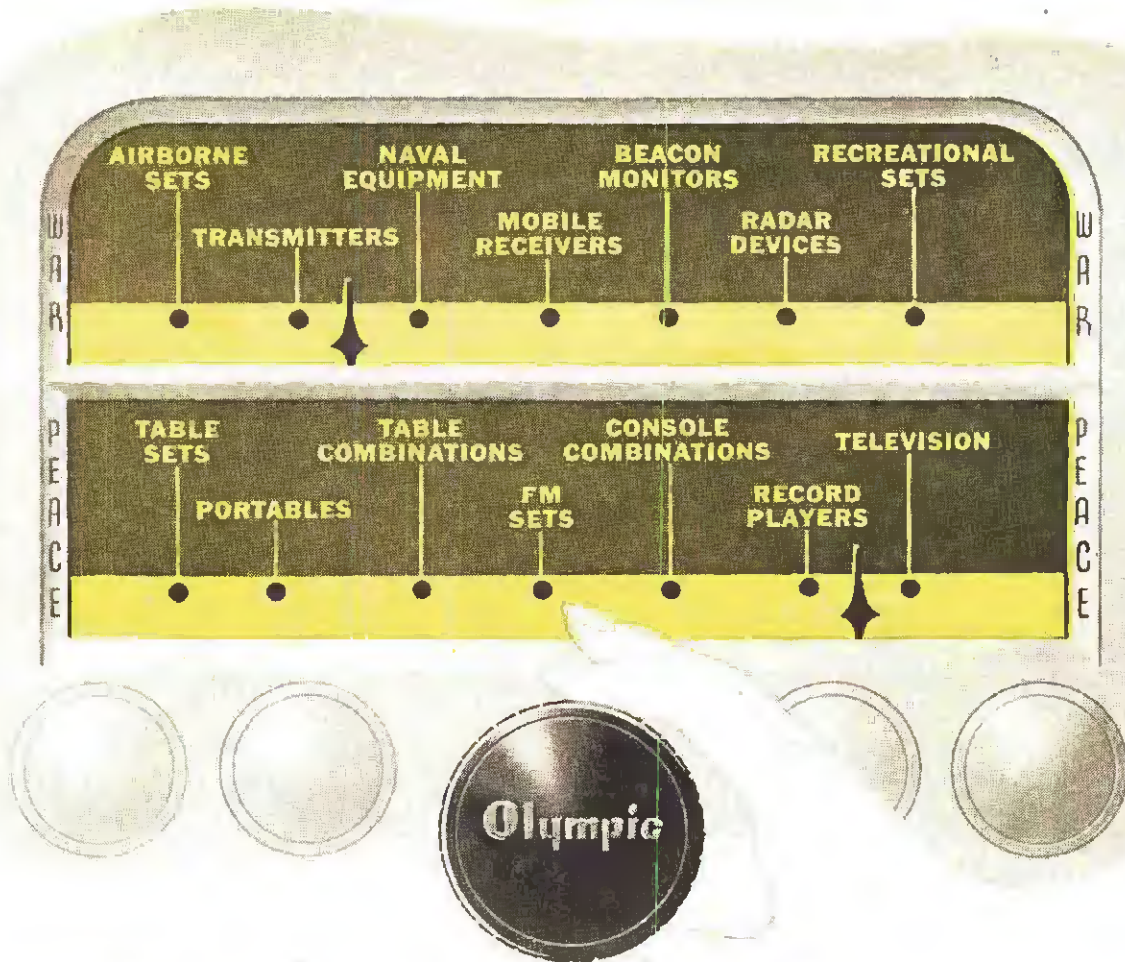

Quick Switch

Radio merchants who identify themselves with Olympic ... will get off to a FAST post-war START. When time counts most ... they will enjoy intimate support from a flexible, fast-moving factory organization ... that has carried out 37 diverse Army and Navy assignments—and never once been late. The sheer variety of Hamil-

ton's work in war-time radio and RADAR... paves the way to rapid, sure-footed RE-conversion. Like flicking a switch, Olympic war-fought betterments will be ready in dependable volume. Olympic Radio & Television, (Division of Hamilton Radio Corporation), 510 Sixth Avenue, New York 11, N. Y.



DIVISION OF HAMILTON RADIO CORPORATION • 510 SIXTH AVE., NEW YORK 11, N. Y.



Enlarged and attractive interior of record department gives evidence of the Tuckel's wartime planning and ingenuity.

Hartford, Conn., Dealers Keep Up with Times. Emphasize Repairs, Recording, and Record Sales

Sidelines a Mainstay Now

• Jack and Max Tuckel have been Hartford's top-flight independent retailers of radios and appliances since 1927. In their location at 1083 on Main Street they still do a considerable business, with variations, in accordance with these times.

Formerly they sold well known makes of major appliances, including refrigerators, washers, electric ranges, some ironers, and radios. Fifty per cent of their sales were in appliances, with refrigerators and washers heading the list. Radio receivers both large and small were carried and made up the other half of the business.

About four years ago the record department was added to accommodate combination purchasers.

The stockpile of radios and appliances which Tuckel's had acquired before the shutdown on civilian manufacturing had been ample to supply their customers until about six months ago.

Specializations Change

Today their main operation consists of service on all radios and appliances brought into their store's repair department. No pickups or deliveries are made.

In addition to this, the record department has been enlarged and attractively displayed.

The second floor has one of the few recording studios in the area.

Tuckel's service manager, Ralph Sisson, is also a recording specialist and has charge of this department. Tuckel's studio caters to service men and women making discs to send home, and for local folks to send to their sons and daughters in the armed forces. Amateur and professional artists record here; and for the charge of the blank only, Tuckel's accommodates their local branch of the War Finance Board in taking local heroes' speeches off the broadcast records, for presentation to them and their families.

Asked about postwar plans, Jack Tuckel says, "We take the customer's viewpoint always. In the case of priority appliance purchase plans, we are not too eager to put this kind of arrangement into motion because we believe it is now too far in advance to be sure of exactly the type merchandise that will be available, or exactly what the customer will want." The Tuckels do believe in keeping abreast of the times and in being ready for quick and immediate expansion, by keeping going right now!

Jack Tuckel, left, and Ralph Sisson, his service manager in their model recording studio.





182,826
Man Hours of
RESEARCH

Since Pearl Harbor, International Detrola research engineers have logged this amazing total in their successful efforts to develop and improve Mine Detectors, Aircraft Radio Transmitters, and Receivers, and many other important military electronic devices. The company's other engineering groups also have made great contribution to the quality and volume of electronic weapons streaming from its efficient Detroit assembly lines to the many battlefronts of Victory. The same engineering inventiveness and trained imagination will be an inseparable quality of Detrola-built Radio Receivers, Television Receivers, Automatic Record Changers, and other electronic instruments.

DETROLA RADIO
DIVISION OF INTERNATIONAL DETROLA CORPORATION - BEARD AT CHATFIELD, DETROIT 4, MICH.
C. RUSSELL FELDMANN  PRESIDENT

BUY MORE WAR BONDS

Two miles up - with an ear to the ground

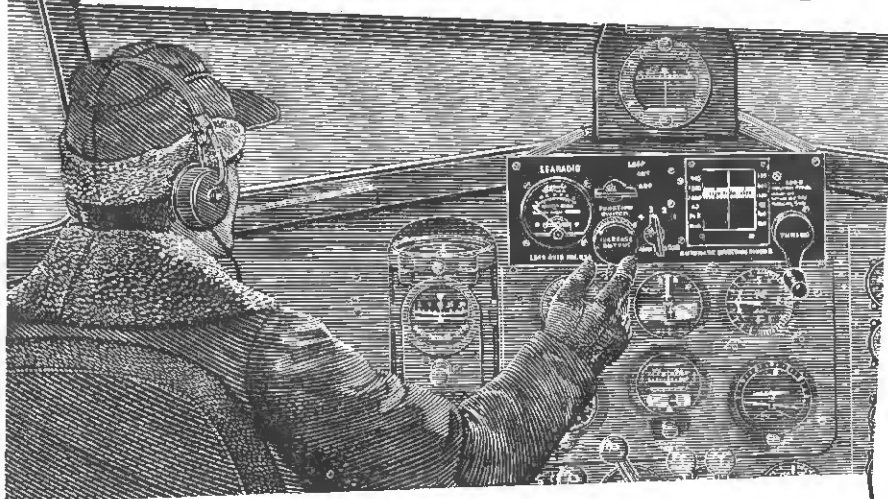

Keeping posted high in the air is one secret of successful flying. The ground keeps track of the plane. The plane knows the weather, the course, and what it's like at the field.

Lear was among the very first to make aircraft radios — had gained an enviable reputation for fine radio and navigation instruments long before the war — was ready when war needs demanded greater and greater technical development.

Some of these developments can't even be mentioned now. They're too secret. Some are in the field of electric aircraft con-

trols. Some will have no use outside of war.

But there are others that hold vast promise for everyone when peace returns.

With its war job done, Lear will turn its discoveries, its developments, the resources of its laboratories and plants toward adding new comforts, new conveniences, new pleasures to the lives of America's families.

PLANTS: Piqua, O., and Grand Rapids, Mich.
BRANCHES AT: New York, Los Angeles, Chicago,
Detroit, Cleveland



Formerly Lear Avia, Inc.

Dealers

Distributors

★

Look to Lear

Wait for Lear

Already the public is being promised fine radios by Lear. It's been a great name in aircraft radio. It's assurance of the finest in audial and visual entertainment at war's end.

Dealers interested in the Lear franchise, should write:

LEAR, INCORPORATED, RADIO DIVISION, PIQUA, OHIO

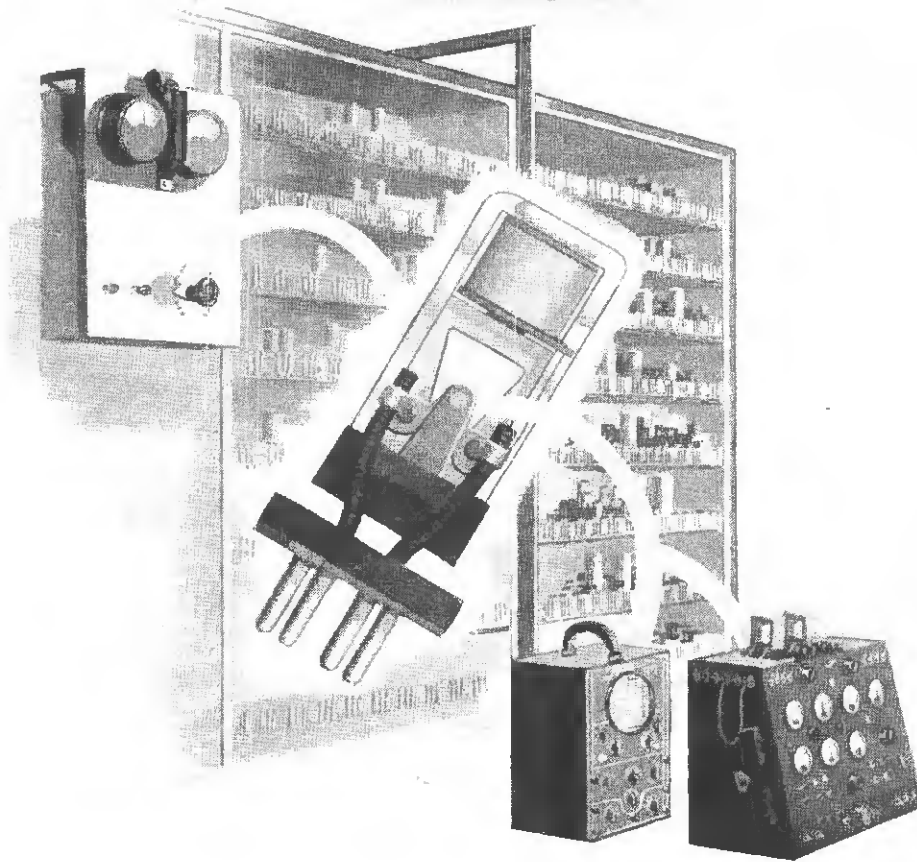

object — longer life

Here in our laboratory on a test rack these Utah Vibrators are placed in continuous operation against the time-clock . . . until they finally break down.

Thus Utah engineers prove the worth of design and the quality of materials that give their product such an enviable record of long, trouble-free service.

Such tests as this have been the reason for Utah reliability in war—and are the Utah guarantee of industry and consumer satisfaction in peace.

★ ★ ★

Every Product Made for the Trade, by Utah, is Thoroughly Tested and Approved



Keyed to "tomorrow's" demands: Utah transformers, speakers, vibrators, vitreous enamel resistors, wirewound controls, plugs, jacks, switches and small electric motors.

utah



Utah Radio Products Company, 810 Orleans Street, Chicago 10, Ill.

Rolling Stock

Suttle, Lawrenceville, Ill., Has Novel Plan in Distributing. Offers Dealers Door to Door Delivery of Appliances.

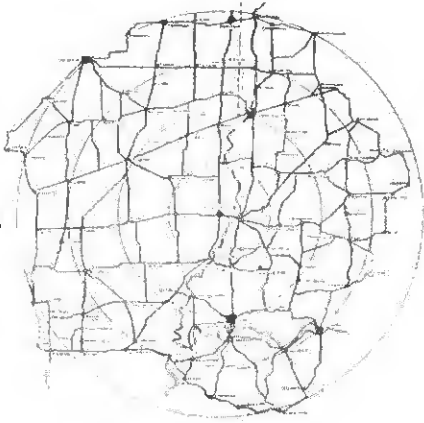

• The Suttle Equipment Co., Lawrenceville, Ill., is completing a post-war setup for wholesaling electrical home appliances and electrical lines for retail stores, and expects to service dealers in towns within a radius of approximately 125 miles from Lawrenceville.

A statement by the company says that "The distribution methods and services offered are different from those normally offered by wholesalers, jobbers or distributors."

Here is the plan Suttle is offering, as outlined in a catalogue it is currently distributing to established and prospective dealers:

Catalogue Pointers

1. No salesman ever calls on you to sell you a bill of goods.
2. You buy only what you know you have sold.
3. You maintain only a floor display and demonstration stock, except on smaller items where you may wish to have a few extra on hand for "cash and carryout sales."
4. You can run your store successfully in this manner because every third day a big truck rolls up to your store and delivers any merchandise you have sold up to 36 hours previously.
5. The Suttle Equipment Company does not waste any money trying to sell you goods to put on your floor and sell to somebody else. It merely delivers to your store any electrical goods you sell to a customer, almost before the customer has reached home.
6. Because Suttle Equipment Co. does not spend any money trying to sell you, it uses this money to give you services that really help you to sell your

prospects and customers much more effectively.

The Suttle catalogue describes this plan as follows:

"Now, let's think about that last No. 6 statement. It is readily apparent that in the long run no wholesaler is going to sell a dealer any more merchandise than the dealer sells to his consumer customers. (Unless the dealer gets stuck.) The ideal set-up, really, is one in which both the dealer, and the wholesaler, concentrate their combined selling effort on selling the user. Then you, the dealer, will sell more goods, and so will the wholesaler you order them from. Of course, that makes sense to both you and us.

"The trouble is, that in the ordinary store set-up the average jobber salesman tries to stock you up all he can. If he doesn't do it some other salesman will. He argues that if you don't have the merchandise, how are you going to make a sale. So both you and the jobber salesman use up a lot of time and money which does neither of you any good so far as additional sales are concerned.

"Of course, if you trade with a lot of different wholesalers, there is no other way to do business.

Free Truck Delivery

"In the Suttle plan you order practically all your goods from Suttle, so you eliminate these problems. You and all the other dealers get together with Suttle once every three months and we all decide together what we want to handle, if the discounts, and quality, and other services offered by manufacturers are satisfactory to us.

"Suttle maintains a free truck delivery service that runs a regular route all over the territory so you get deliveries of goods just as regularly as you get your milk delivered by your milk man.

"Now, take a look at the map, and note your location in relation to Lawrenceville. You will readily see that six or more big trucks could easily cover every town in the territory in and out of Lawrenceville twice a week. There is a direct paved highway from Lawrenceville to your town.

"Suttle can also afford to deliver the merchandise free in its own trucks because it saves packing, writing out bills of lading, billing shipping charges, hauling to the freight houses, returns and allowances, and other expenses. Instead of spending mileage for salesmen on the road we put it in trucks making deliveries to you.

A Central Warehouse

"By now, you begin to get a general idea of the merchandising methods recommended to you by Suttle. You begin to see how a lot of natural savings work to your advantage as an independent store dealer when you and a group of 85 to 100 other such dealers will all work together through one central warehouse. Bear in mind that the management of this central warehouse concentrates all of its effort in serving these 85 to 100, to the exclusion of all others."

Some of the other features stressed by The Suttle Equipment Company include: repair services, catalogues especially imprinted with dealer's name, mat and copy advertising service, help with store decorations, selling help, conferences, collection agency services and monthly cash settlements.

Suttle's plans to offer dealers free rides on its trucks in order to enable them to visit dealers along the routes and see how others are conducting their businesses.

Another plan of the company is to furnish dealers with a fixed trade-in allowance sheet showing amounts Suttle will pay for items traded in by the dealer's customers.

DYNAMIC PROMOTION TODAY BUILDING SALES FOR TOMORROW

Emerson Radio

The post-war
plan that's
clicking NOW!

Ask Your
Emerson Radio
Distributor



* **P.D.Q.**

**PREFERENCE
DELIVERY
QUOTA**



P.D.Q. PREFERENCE DELIVERY QUOTA Plan—for Franchised Emerson Radio dealers. A complete merchandising set-up that is pulling customers into dealers' stores for service and for goods now on hand—piling up for them "preference" orders for the new "miracle sets" as soon as they come off the line.

P.D.Q. is being featured in Emerson Radio's national advertising. The merchandising "package" includes powerful window and store displays—with impressive Preference Registration Book and tie-up Consumer Certificates for later follow-up—all at no cost to you.

P.D.Q. is the most concrete and constructive promotion plan in radio today. Consumer "preferences" are pouring in by the thousands—building a huge waiting market for Emerson Radios.

P.D.Q. merits your immediate action. Call your Emerson Radio distributor now for complete details—or write direct to factory.

EMERSON RADIO AND PHONOGRAPH CORP., New York 11, N.Y.

MAIL COUPON, attached to your letterhead, for complete details of Emerson Radio's spectacular P.D.Q. Plan.

Emerson Radio & Phonograph Corporation
111 Eighth Ave., New York 11, N.Y.

Gentlemen:

I have a retail store and am interested in your P.D.Q. plan. Please send details.

Name of Individual _____

Name of Store _____

Street _____

City _____ State _____

RT

For Outstanding Accomplishment.



GREAT ENGINEERING IDEAS IN SMALL PACKAGES . . . COMPACT, EFFICIENT, FINE

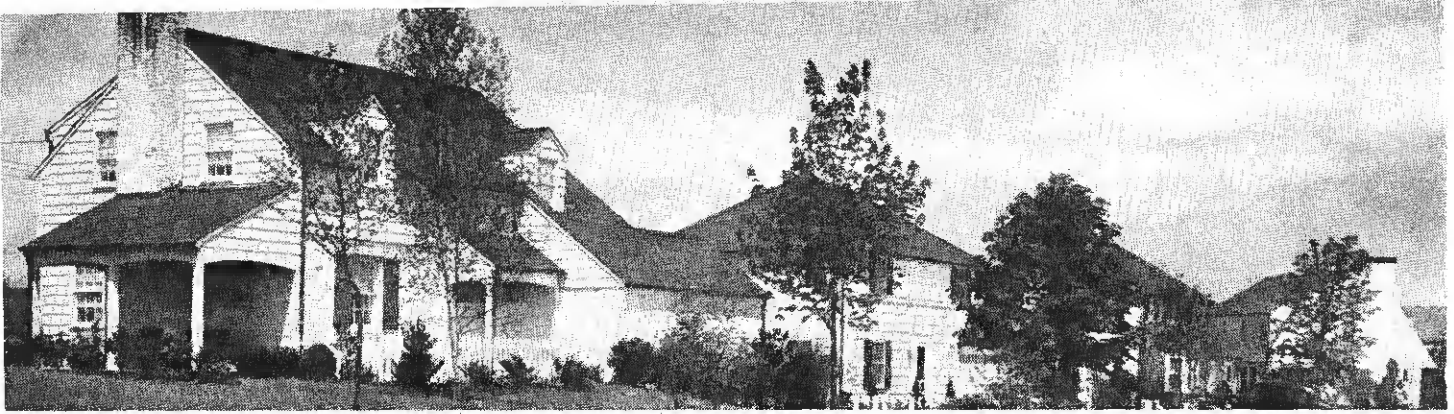

Homes like these in this picture by Ewing Galloway, N. Y., will be in the market for household conveniences when civilian manufacture starts.

Appliance Horoscope

Yesterday's Sales and Today's Demand Give Pre-View of Tomorrow's Possibilities

• A dealer doesn't need to be a swami to see with perfect clarity the magnitude of tomorrow's home-appliance business prospects. As a matter of fact, the retailer will be perfectly justified in borrowing a few fifty-dollar adjectives from the Hollywood movie publicity men in describing the postwar selling market as certain to be "colossal, gigantic, stupendous, phenomenal and breath-taking."

Current Status Predicts

Figures of all sorts show tremendous potentials, but in view of the fact that there is a sky-high demand *now*—a demand impossible to alleviate to any marked degree, due to manufacturing bans—and that there is a continuous stream of obsolescence trickling through existing appliances, due to curtailment of parts and service, it is doubtful if any of the estimates for tomorrow's appliance business are *high enough!*

Bright Prospects

And that's not a gloomy picture for the dealer!

Throw an appliance-deprived public into the buying and selling arena, with scads of folding money, and what happens? They buy—that's all. And the dealer sells.

So, in the hope that a simple chart, such as the one which follows, will aid radio retailers who have not before been in the electrical appliance business, we've tried to stress some of the points of interest of appliances, and have not included radio and associated lines, since their possibilities in the future are only too well known to those who have been successful with them in the past.

LEADING MAJOR APPLIANCES: ELECTRIC REFRIGERATORS

Selling Features: Health through food preservation—low operating costs—can buy perishable food when cheap and store it—can make frozen desserts and salads—adds to kitchen's attractiveness—gadgets and freezing controls.

Average Prices: (Retail, pre-war) Counting all the "trade-ins" and inducements, say \$89.95 to \$325.

Past History: Banged around a lot, but many made real money selling them. "Stripped" 6-foot models went like wildfire just before war at \$158.50. Dealers who explained 5-year warranty was on the unit *only*, saved themselves headaches. Next to radio, electric refrigerator has greatest sales appeal to the home-dweller. Leaders were bought by brand-names; "weak sisters" through price inducements. "Everybody and his brother" making them, or just about to do so when war came.

Postwar Prospects: Immediate conventional models with few innovations. Later, frozen-food compartments; revolutionary cabinet designs—interior humidification control—probably drastic innovations in refrigerants. Greater storage flexibility, with no "musts" for placement of certain foods. Some think "motorless" units, using electric heating elements, will be featured. Sales prospects tremendous, to replace worn-out boxes and for new buyers.

CLOTHES-WASHING MACHINES AND IRONERS

Selling Features: Health and no danger of contamination of clothes—Economy of operation—Ease of operation—Clothes last longer since no "harsh" cleansing agents are used, apply to washers. Home ironers (never "mangles" to your prospective buyer) afford quick, economical ironing service; not fatiguing to operate.

Average Prewar Prices: Washers about \$39.95 up to \$169.50 for wringer models; centrifugal "spinner" types, \$99.50 to \$179.50—"automatics," higher. Ironers, roughly \$29.85 up.

Past History: Selling technique of past, home demonstration, approved by most sellers. Washers were good money-makers, and prices stood up fairly well. Makers found that *colors* were very important, and their "greens, buffs, blues" abandoned in favor of black and white or plain white. Big trend to automatics just before war, but conventional types sold well. Ironers had to be thoroughly "sold." Buyer must be convinced it "takes practice" and patience.

Postwar Prospects: Look for many manufacturers to go "automatic" in washers, and greatly improve ironing machines. Free tip to manufacturers who've been eying low saturation figures of great cities. Bring out a "midget" type washer with an automatic means of water-extraction such as "a spinner" or motor-driven wringer, and see what happens. Believe the city folk will pay up to \$75.

(Continued on page 65)

RCA LEADS THE WAY

KEEPING YOU UP TO THE MINUTE ON TUBE DATA

YOUR business demands that you always have reliable, up-to-date tube information and data at your fingertips for future planning, as well as for today's restricted operations. RCA gets this information out for you when you need it, and the way you need it . . . in a clear and usable form. It's one more service for which distributors, dealers and servicemen look to RCA . . . a part of RCA's continuous merchandising program to provide sales support for you.

Listed here are some of today's most popular RCA publications. They are all available to you—through your RCA distributor, or direct from Radio Corporation of America, Commercial Engineering Section, Dept. 62-22A, Harrison, New Jersey.

1. RCA Tube Substitution Directory
—Lists for radio servicemen over 2000 substitutions for civilian receivers. Includes data on space limitations, circuit and socket changes involved. 16 pages, 8½" x 11", price: 10¢.

2. RCA Receiving Tube Manual (RC-14)
—Basic tube theory, application data, circuits and charts on 340 RCA receiving types. 256 pages, 5½" x 8½", price: 25¢.

3. RCA Receiving Tubes and Allied Types Bulletin (1275-B) — Characteristics and socket connections of RCA receiving and allied types. 16 pages, 8½" x 11", single copies free.

4. RCA Guide for Transmitting Tubes
—Data and circuits for popular power tubes, uhf acorn types, gas-triodes, and gas-tetrodes. Special chart showing air- and water-cooled tubes, rectifiers, cathode-ray tubes, phototubes, voltage-regulator tubes, and special tubes. Facts on design, adjustment, and operation of transmitters. Illustrated. 72 pages, 8½" x 11", price: 35¢.

5. RCA Power and Special Tubes Bulletin (TT-100) —Covers air- and water-cooled transmitting tubes, rectifiers, television and oscillograph tubes, phototubes, thyratrons, voltage regulators, and special amplifier tubes. Charts of modulator and class C amplifier data, 16 pages, 8½" x 11", single copies free.

6. RCA Phototubes Bulletin —Phototube theory. Data on 15 types. Circuits for light-operated relays, light measurements, and sound reproduction. 16 pages, 8½" x 11", single copies free.

7. RCA Radiotron Designer's Handbook Valuable to anyone interested in principles of circuit design. Illustrated, with charts, tables, and miscellaneous data. 356 pages, stiff cover, 6" x 9", price: \$1.00.

8. RCA Tube Handbook—All Types (HB-3) —Two loose-leaf volumes of data and curves on all RCA receiving, transmitting, cathode-ray and special tubes, and phototubes. De luxe binders, 5" x 7½". Available by subscription. Write for descriptive folder and order form.

The Magic Brain of all electronic equipment is a Tube . . . and the fountain-head of modern Tube development is RCA.

1919

1944



25 Years of Progress
in Radio
and Electronics

RADIO CORPORATION OF AMERICA

RCA VICTOR DIVISION • CAMDEN, N. J.

LEADS THE WAY . . . In Radio . . . Television . . . Tubes . . .
Phonographs . . . Records . . . Electronics



LISTEN TO
"The Music America
Loves Best"
Sundays, 4:30 p. m.
E. W. T.
NBC Network



**RCA ELECTRONIC
TIME-INTERVAL COUNTER
at Aberdeen Proving Grounds**

It splits a second into 100,000 parts

NEITHER the human eye nor an ordinary clock could come even close to timing an invisible shell in flight. Yet the RCA Time-Interval Counter does it electronically to one one-hundred-thousandth of a second. This close watch kept on standards for guns and ammunition of the Army and Navy is a big reason why our enemies dread the accuracy of American fire power.

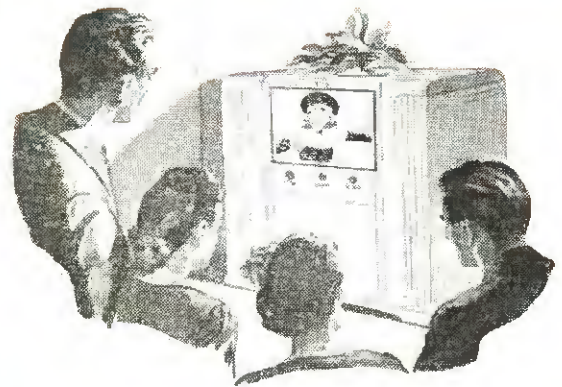

By selling home television receivers in volume, America's radio dealers will have an indispensable part in the spread of commercial television after the war. RCA aims to make that job easier for you by producing sets priced within the reach not just of thousands—but of *millions*.

LISTEN TO RCA's radio program, "The Music America Loves Best" . . . every Sunday, 4:30 P.M. EWT, NBC Network

TODAY THIS EXPERIENCE WORKS FOR UNCLE SAM

...after V-Day it will work for you

The same world-famous RCA engineering that produces electronic devices for our armed forces will make the finest radios, phonographs and television receivers ever built.

BEFORE the war thousands of fine radio-phonographs like these found a ready market. After the war, RCA dealers will have even finer merchandise to work with . . . new, beautiful cabinet designs . . . the most modern electronic circuits, including the wonderful natural tone and static-free reception of RCA Super FM.

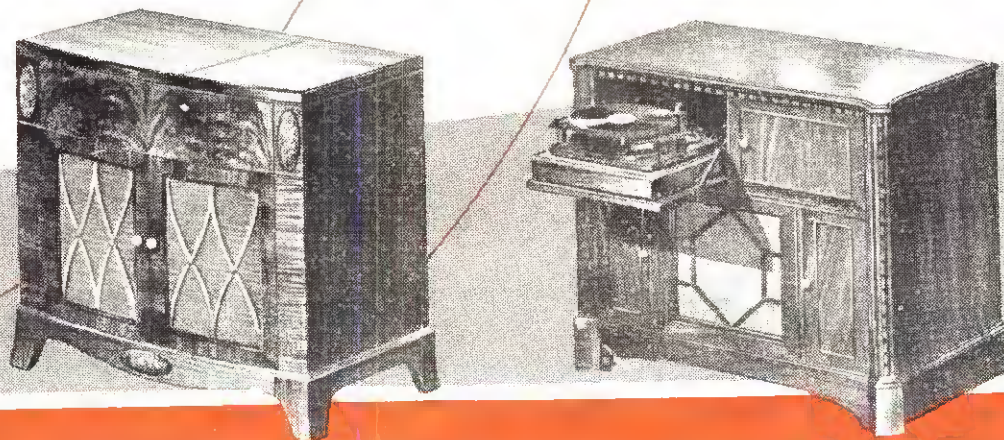

RADIO CORPORATION OF AMERICA

RCA VICTOR DIVISION • CAMDEN, N. J.

LEADS THE WAY . . . In Radio . . . Television . . . Tubes . . . Phonographs . . . Records . . . Electronics

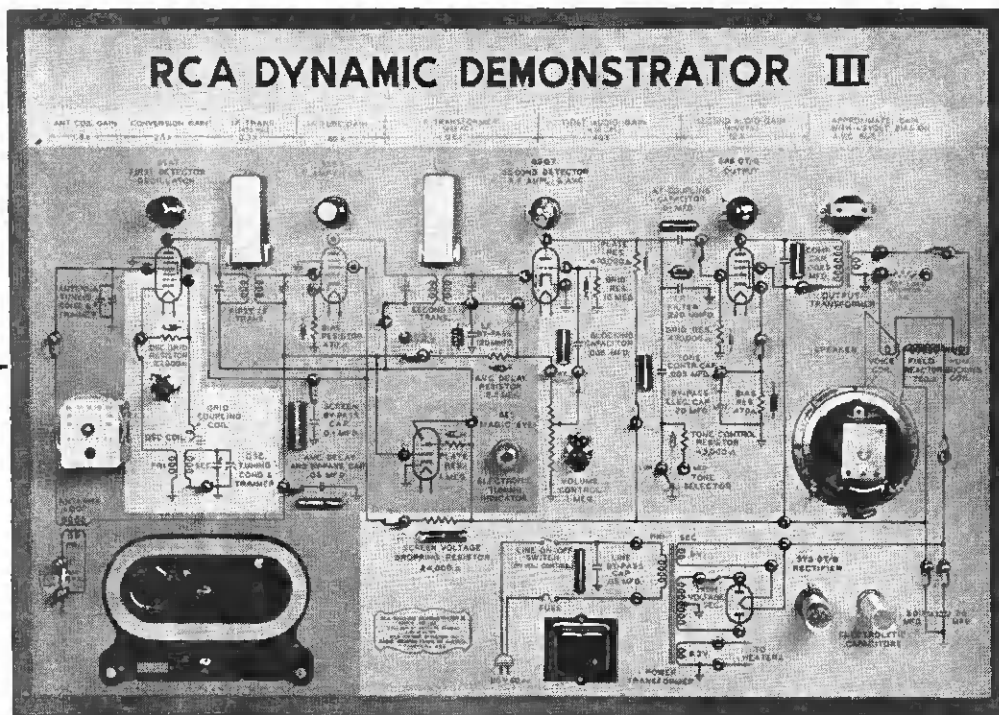

The Working Schematic Circuit Diagram that has helped thousands to learn radio principles, circuits, and servicing

The RCA Dynamic Demonstrator is a complete schematic diagram of a modern six-tube superheterodyne radio receiver; all circuits clearly visible; all operating parts mounted in their proper places in the circuits; the correct symbol representing each respective part in plain sight beside that part; and the whole hook-up arranged in perfect working order.

Each Circuit Section in Different Color—Large color-blocks differentiate each circuit section: the power section is blue; audio frequency, green; intermediate frequency, orange; oscillator, yellow; radio frequency, red.

Pin Jacks and Switches—At all important measuring points there are pin jacks for instrument connections, or insertion of jumpers. All types of part or circuit failures can easily be simulated to facilitate effective methods of location and correction. Other types of simulated failure

can be realistically produced by operating switches provided on the back of the Demonstrator.

Typical Applications—A specially prepared RCA Instruction Manual is supplied to help teachers and students use the RCA Dynamic Demonstrator to best advantage. This instruction booklet contains many well-illustrated suggestions for helpful experiments, with adequate explanations of the nature, purpose, and significance of each experiment.

Write for Data—A large number of RCA Dynamic Demonstrators are now being used in schools and colleges and for radio instruction of the armed forces. For complete information regarding this interesting and valuable radio teaching aid, write to Test & Measuring Equipment Section, RADIO CORPORATION OF AMERICA, Camden, New Jersey.

★ BUY MORE WAR BONDS ★

1919-1944—25 Years of Progress in Radio and Electronics



RADIO CORPORATION OF AMERICA
RCA VICTOR DIVISION • CAMDEN, N. J.

Horoscope

(Continued from page 60)

ELECTRIC RANGES

Selling Features: Many believe these appliances are destined to do a "refrigerator" act in the postwar market. Cleanliness, silence of operation. Better cooking because low-temperature, controlled heat makes cheap cuts of meat taste like the best. Safer than all other cooking methods—won't blacken utensils. Can be automatically operated while housewife is absent from home. Appearance enhances beauty of kitchen layout.

Average Prewar Prices: \$59.50 up for the non-portable type range. Higher priced models up to about \$300. Average installation costs between \$50 and \$100.

Past History: Some localities did a big business in them where rates were reasonable. Can be operated where rate goes down to 2 cents per kilowatt, more economically than gas, dealers point out. Sales mostly clean—not much price-cutting.

Selling Obstacles: Belief of many that electric ranges are "slower" than gas, and the necessity for pulling a heavy electric service into the home. This service, however, allowed homeowner to use more and heavier electric appliances in addition to his range. Many utility companies bore about half of the cost of such installation.

Postwar Prospects: As stated before, ranges may prove whirlwind sellers in the postwar period. New models will doubtless have more and better automatic controls, and the designs will be greatly improved. "Console" types will probably be demanded by women, who would rather sacrifice convenience for appearance. Low-down oven forces them to sit on their haunches.

ELECTRIC VACUUM CLEANERS

Selling Features: Ease of operation. Health through cleanliness, rug preservation.

Average Prewar Prices: \$9.95 to \$149.50. This included the gamut of types and models from the "straight suction" hand-cleaner, through the power-driven brush types with all "attachments" to the "tank" types.

Past History: The history of vacuum cleaner is predicated upon the history of patent expirations. When the motor-driven brush type patents became public domain, there was an immediate swing to this by makers. Before the war the "tank type" became very popular. Some makers offered only a revolving brush type, with complete attachments as an inducement. Others stressed "combinations"—hand-cleaners, with attachments to augment the revolving brush model. Many makers manufactured "tanks," straight-suction models, revolving-brush types and hand cleaners, both straight suction and revolving brush kinds. Names mean a lot to cleaner buyers, since most are women, and many insist upon buying the same make which gave them good service in the past. After years of plugging, some of the big-name makers not pioneers in the field, have been able to secure general acceptance of the cleaners at this time. Home demonstrations have always been the best sales methods.

Postwar Prospects: Look for increased power, quarter-horse and up—plastic cases—brighter headlight lamps—throw-away dust bags—improved methods of driving revolving brush, doing away with belts—automatic raising and lowering of nozzle—most demanded feature, silent operation—some writers predict big sales for suction mechanism in basement, with lines in rooms throughout. Nothing new about this—many oil burner men have bought these old tanks up and are using for furnace cleaning—choice between "tanks" and floor models... who knows?

AUTOMATIC OIL BURNERS, DOMESTIC

Selling Features: Economical operation—freedom from labor and dirt—automatic temperature control—"summer" domestic hot water supply—opportunity to make basement into recreation room.

Average Prices: In the East, conversion jobs, with 275-gallon inside tank, ran as low as \$150, and up to \$395, roughly. Boiler-burner units were being installed at a wide variety of prices.

Past History: Many "factory branches" in selling field, but lots quit. Oil-burner sales picture changed abruptly when oil deliverers entered it, many installing burners without profit to secure oil business. Like other major appliances, leaders bought

on name, "weak sisters" through price inducements. Pioneer dealers with many installations popularized trade names in some localities. In early days most sold through taking prospective customer to basement of satisfied user.

Postwar Prospects: Oil-burner dealers worried plenty when oil famine came; now coal situation just as acute, has justified situation. Chiefly three domestic types: Pressure (gun-type), vertical rotary (suspension or impingement flame) and retort-type (no moving parts in boiler, but with mechanical air introduced).

Tomorrow's type? Who knows. Complete "package" units doubtless will predominate sales, since greater economy is stressed and units have more eye-appeal. Air-conditioning has big future, combined with automatic heat.

OTHER APPLIANCES:

Ultra-violet ray "sunlamps" were just beginning to break through customer resistance. Look for big sales in them. Through use of special glass to filter out short-wave rays harmful to eyes, sunlamps recently sold did away with necessity of wearing goggles, and could be used as reading lamps. Sales should tie in well with the present, growing vitamin craze, since they provide Vitamin D with much faster absorption into the blood stream than the drug method. Medical associations now permit dealers to sell them as "specifics against rickets"—Postwar models will doubtless have infra-red lamps too, with switch control and automatic timer. Popular prewar price for floor models was about \$49.95—many equipped with new S-4 lamp.

Kitchen Mixing Machines: Dealers made plenty out of these, and leading makers bent every effort to keep the list prices in effect. Leaders sold for about \$22, and offered many "attachments" such as meat grinders, vegetable slicers, graters, shredders, can-openers, silver polishers, etc.

Table Appliances: In order of sales volume, automatic and non-automatic toasters, electric coffee makers and percolators, sandwich grills and waffle irons. Electric broilers showed promise—electric roasters, plugged to the limit by many big makers, moved very slowly in some sections of the country. Makers should call a con-

(Continued on page 88)

POWER AMPLIFIER

Operating Characteristics and Per AB, and C Power Amplifier Stages.

• Three forms of distortion of the original signal may be present in vacuum tube amplifiers.

(1) Frequency distortion. — An amplifier which does not have the same gain at all frequencies is said to have frequency distortion. Fre-

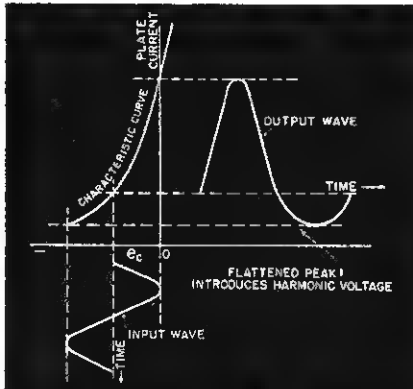

Fig. 1. Amplitude or harmonic distortion caused by curvature of grid control characteristic.

quency distortion is primarily a function of the type of coupling used between stages. Frequency distortion is undesirable in audio amplifiers, but desirable in amplifiers designed to separate signals on the basis of their frequency. The general frequency response characteristics of amplifier coupling systems were covered in the August issue of RADIO & Television RETAILING.

(2) Harmonic or amplitude distortion.—A so-called "pure" tone contains only one frequency. If a pure single frequency is to be amplified, and is to remain pure, all amplification must be strictly linear. The best amplifiers approximate this performance closely but in all cases some new frequencies are generated that are multiples of the input tone. This is called harmonic or amplitude distortion. From the standpoint of hearing, the most objectionable harmonics are the 2nd, 3rd and possibly the 5th and 7th for the double reason that they are relatively strong and the frequencies are usually low enough to appear within the audible region.

Amplitude distortion is caused by the non-linear characteristic of the tubes. This is shown by Fig. 1. Large signal amplitudes are distorted

more than small values. The general result is a "flattening" of the negative half-cycle which is equivalent to adding a second harmonic 90° lagging the original pure tone. The correct value of grid bias is essential in minimizing amplitude distortion.

In any reasonable design of an audio amplifier, the early stages do not introduce much harmonic distortion, as the signal voltage is still low compared to the tube voltages, and the loads of the tubes are substantially resistive. In the later stages these favorable conditions do not prevail, especially if the load is electro-mechanical, such as loudspeaker or a record-cutting head. Such devices apply a load to the tube that varies not only with frequency, but with amplitude and other factors. Because of this and the high signal voltage applied to the tube, relative to the direct voltage, non-linear distortion appears.

By trial and experience it has been

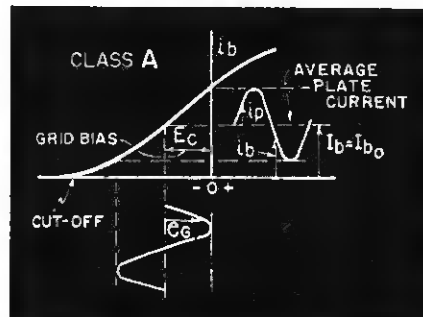

Fig. 2. Theoretical operation of class A amplifier stage, showing bias, grid signal voltage and plate current variations.

found that about 2 per cent of harmonic distortion is the least which even a trained observer, working with a single pure tone, can distinguish. Beyond this point, harmonic distortion becomes apparent quite rapidly: 5 per cent is not hard to distinguish, and 10 per cent is objectionable. These percentages are totals of all the harmonics because it is comparatively quick and simple to measure them together, and more tedious to sift them out singly.

(3) Phase distortion.—Most signal voltages are not sinusoidal, but have a complex wave shape. This complex wave is composed of a fun-

damental sine wave and a group of harmonics. If the phase relations of these components are changed, the resultant wave shape will be different. This delaying of certain frequency components is phase distortion. It is not serious in audio amplifiers but must be corrected in wide-band amplifiers such as those used for television.

Basis of Classification

Amplifier operation is classified on the basis of the completeness of the plate current cycle. A Class A amplifier is one in which the grid bias applied to the tube and the signal voltage input are both such that plate current flows for 360° of the signal voltage cycle, and no grid current flows. A DC meter in the plate supply lead should show little or no movement with or without the AC grid input voltage. The plate-circuit efficiency is seldom as high as 20 per cent for triodes, a trifle better for pentodes. The theoretical maximum is 50 per cent. Accordingly, the amount of plate heating limits the performance of tubes in Class A. The alternating plate voltage (R.M.S.) is only about 30 per cent of the direct plate voltage, hence the output is small. The grid bias for a triode Class A tube is about 60 per cent of the theoretical cut-off. For a beam tube, cut-off has a less definite meaning. Class A operation is shown in Fig. 2. Practically all voltage amplifiers operate Class A.

The grid bias for Class B is adjusted to "false cut-off" as shown in Fig. 3. The bias voltage must be obtained from a fixed supply and not from self or cathode bias since the average plate current varies with the magnitude of the signal voltage. The

Fig. 3. Bias for class B operation.

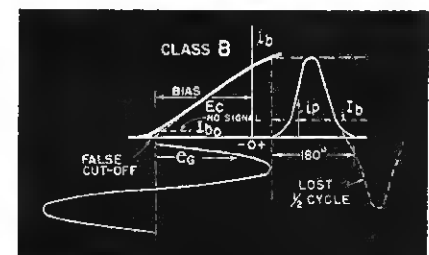

FUNDAMENTALS

Performance Comparison of Class A, B, Bias and Grid Voltage Requirements

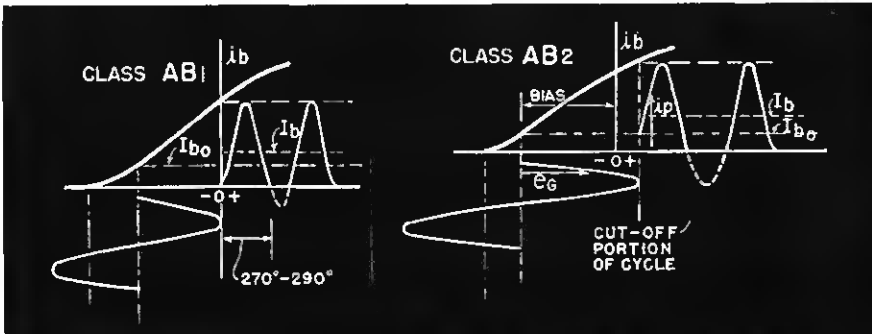

Fig. 4. Principal difference between class AB₁ and AB₂ is magnitude of grid signal voltage at full output. For very small signal voltages, stages are class A. Grid current flows in class AB₂.

value of bias voltage is approximately E_b/μ .

Since the plate current flows for only one-half cycle, great amplitude distortion results. Class B amplifiers are unsuited for audio amplification unless two tubes in the same stage are worked 180° out-of-phase with respect to each other, so that a full cycle of plate current is obtained. This operation is termed push-pull.

Any stage in which there is only one tube (or tubes connected in parallel) is termed single-ended as contrasted to push-pull operation.

Class B Gives Higher Efficiency

Class B operation is more efficient than Class A, having a maximum theoretical limit of 78 per cent. Class B amplifiers are sometimes called linear amplifiers because the voltage output is almost a linear function of the grid signal voltage.

Class B amplifiers are used for high power audio and linear radio frequency amplifiers. A Class B grid represents an actual load upon the driver stage during its positive swing, since grid current flows. The driver must therefore be more powerful than for Class A operation.

Class AB₁ is used to indicate an amplifier in which the instantaneous grid voltage is never positive. Class AB₂ is an amplifier in which the grid is driven positive for a short part of the cycle. It delivers more power than Class AB₁ from the same tubes. Classes AB₁ and AB₂ are shown in Fig. 4.

The efficiency depends on the type

of triode, tetrode, or pentode used, ranging from 20 per cent to 60 per cent, the last being obtained when the input has been increased to the so-called AB₂ level. Here the grids are driven from below cut-off at one end to a small positive potential at the other end of the swing where grid current just begins to appear and a little actual power is required to drive the grids.

The power output of a Class AB₂ pair of tubes is 2 to 2¼ times that of the same tubes in Class A. The distortion need not be much greater if an adequate driver stage and a good output transformer is used. What is generally overlooked, the plate and bias supplies must have very good regulation—that is, do not change in voltage by more than 5 or 10 per cent as the plate current demand varies from “no signal” to “full signal”.

The Class C amplifier operates under conditions of high distortion, yet is frequently used in “single-

ended” amplifiers for power amplification of radio frequencies. The actual condition of operation is that a bias of two or more times cut-off is used. The grid signal voltage is large and produces plate-current pulses, which are always shorter than a half-cycle, but have large peak values. A high plate circuit efficiency of 75 per cent or more results. The plate current waveform is so bad that it is useless for audio work. It is used as RF amplifier, in which the tube load is one or more tuned circuits of good “Q” and high capacitance (relatively), so that the harmonics (caused by distortion) will either be wasted or else converted to the fundamental frequency, by the flywheel action of the resonant plate circuit. Class C operation is shown in Fig. 5.

Class A operation is the least efficient but has least distortion. Its use is limited to voltage amplifiers and small power amplifiers. Bias voltage may be obtained from fixed or self bias methods.

Class B is more efficient than Class A but can only be used in push-pull circuits for audio work. It is often used single-ended for radio frequency amplifiers. The grid bias must be obtained from a fixed source.

The Class AB amplifiers are between Classes A and B in both efficiency and distortion. They are most common as push-pull audio amplifiers.

Class C is the most efficient method of operation but is limited to amplifiers of very narrow bands of frequencies such as RF amplifiers.

Fig. 5. High efficiency class C operation is not suitable for audio work because of large distortion. Bias is commonly about twice cut-off and grid current flows during part of cycle.

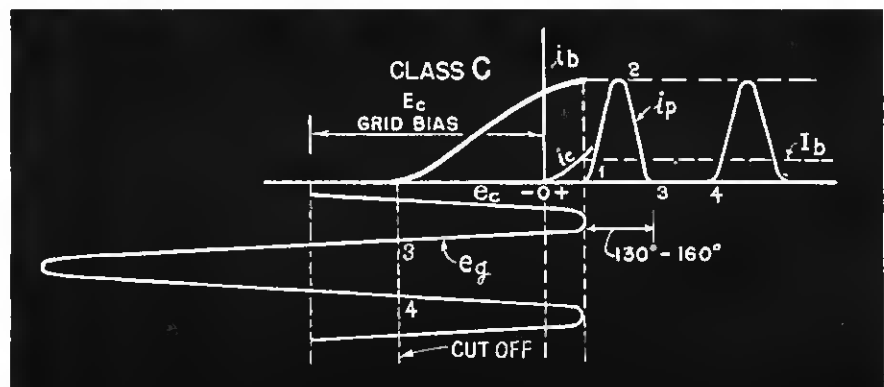



The United States Navy has awarded the men and women of Hallicrafters a special "Certificate of Achievement"... first award of its kind... for outstanding service with the radar-radio Industries of Chicago in speeding vital war material to the Navy. Added to the four Army-Navy "E" awards, this makes five times Hallicrafters workers have been cited for distinguished service. They promise that this kind of service will be continued until total victory is ours.

★ BUY A WAR BOND TODAY

hallicrafters RADIO

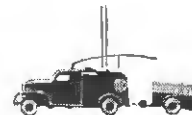

THE HALLICRAFTERS CO., MANUFACTURERS OF RADIO AND ELECTRONIC EQUIPMENT, CHICAGO 16, U. S. A.



Westinghouse

Doolittle
RADIO, INC.

Signal Corps

SPERRY
GYROSCOPE COMPANY, Inc.

Federal Telephone and Radio Corporation

GENERAL ELECTRIC

CROSLEY

WILCOX ELECTRIC
COMPANY

WEBSTER ELECTRIC

RAYTHEON MANUFACTURING COMPANY

Western Electric



THE BEST KNOWN NAMES ON THE WAR PRODUCTION FRONT DEPEND ON THORDARSON QUALITY

Throughout the trying periods encompassed by 3 wars . . . and in all the intervening years of peace since 1895 . . . Thordarson leadership has been accentuated by its association with the most outstanding concerns in America.

Especially on the present world-wide war fronts . . . where the marvels of research laboratories and the handiwork of production geniuses may be seen in action . . . there also will be found the results of Thordarson experience and Thordarson engineering ability.

Thordarson Transformers and Amplifiers are "good right hands" to a host of America's leading organizations who are concentrating on winning the war as quickly as possible. Thordarson products are helping to do everything from making communications easier and more accurate to conducting fatigue tests which insure more dependable airplane propellers. All of these services and experiences, now devoted to war, will enable us to serve you better when peacetime needs are again paramount.



THORDARSON

TRANSFORMER DIVISION
THORDARSON ELECTRIC MFG. CO.
500 WEST HURON STREET, CHICAGO, ILL.

Transformer Specialists Since 1895
ORIGINATORS OF TRU-FIDELITY AMPLIFIERS

What will you need...

IN THE FIRST SIX POST-WAR MONTHS

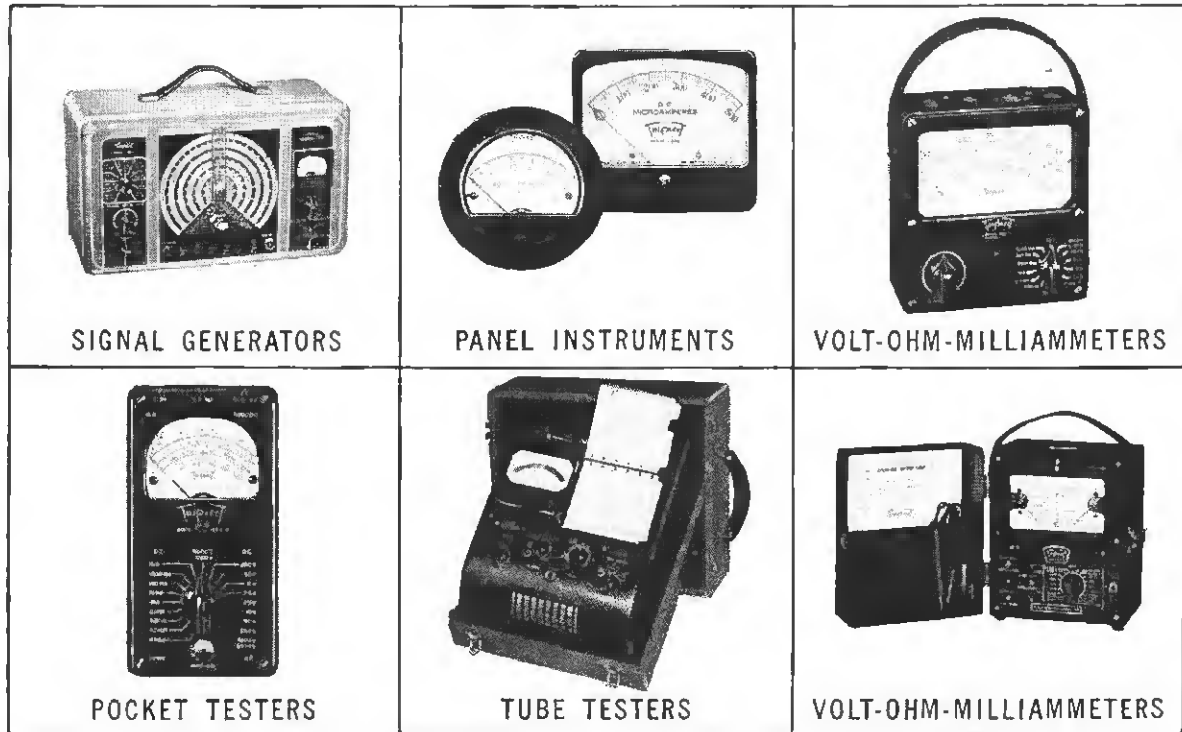

✓ CHECK THE TYPES AND QUANTITY

Now—right now—is the time to protect your post-war business by estimating your future equipment needs. Check those needs, list them and place a *tentative post-war order* with your jobber now. This foresight will enable him to stock the Triplet instruments you will need, and will assure you quicker resumption of civilian business than you could expect if you wait till the last minute. Give best priority you can obtain to facilitate deliveries as production is available.

Newly perfected developments now being produced on important war contracts, and many other outstanding instruments, will be incorporated in Triplet offerings for the first time beginning with our initial civilian production. Be sure you get the complete list of Triplet instruments and radio test equipment.

Triplet
 ELECTRICAL INSTRUMENT CO.
 BLUFFTON OHIO ***

STANDARDS ARE SET BY

WE'RE MAKING

Phonolas NOW...



They're olive drab and their containers are reinforced with steel, but they're unmistakably the latest, finest members of America's oldest and largest portable phonograph family—the famous Phonola line.

While most of our manufacture is still centered on war-needed electronic devices, these Phonolas in GI guise will be our springboard into peacetime production. And their advanced technical innovations will be carried over into our post-war mechanically and electrically amplified phonographs—Phonolas of greater beauty, performance, and value than we've made in all our twenty-eight years of leadership.

Watch for the new Phonolas!



Phonola

WATERS CONLEY COMPANY
Rochester, Minnesota

New York office: 17 East 42nd Street
VANderbilt 6-2079

Chicago office: 224 South Michigan Avenue
HARRISON 1880



Cabinets Ready!

The most exacting popular demands are fully met in the styling and construction of these exquisite cabinets.



Chassis Engineered!

Into these chassis for SONORA'S trade have gone world-wide research and years of exacting war experience.

37 Sonora *Clear as a Bell* **RADIOS AND PHONOS!**



Working Samples Approved!

Flawless operation is insured through laboratory tests under every condition of reception.

37 SONORA models are ready—a brilliant line to fit the need of every radio buyer, no matter where he lives, no matter what he wants to spend. From the smallest table model to the finest F-M combination, from recorders to portables and table model phonoradios, the SONORA line is complete:

SONORA'S great cabinet and chassis plants are ready for the gong—to jump into civilian production on as large a scale as WPB permits.

And SONORA'S market is ready, primed and eager, cultivated by a colorful, consistent national advertising campaign that has reached new peaks of readership and interest.

SONORA is ready—to help you cash in on the boom market just ahead.

Sonora *Clear as a Bell*

SONORA RADIO & TELEVISION CORP.

325 N. Hoyne Avenue, Chicago 12, Illinois

RADIO & Television RETAILING • October, 1944

TURNER MICROPHONES

Partners in Performance

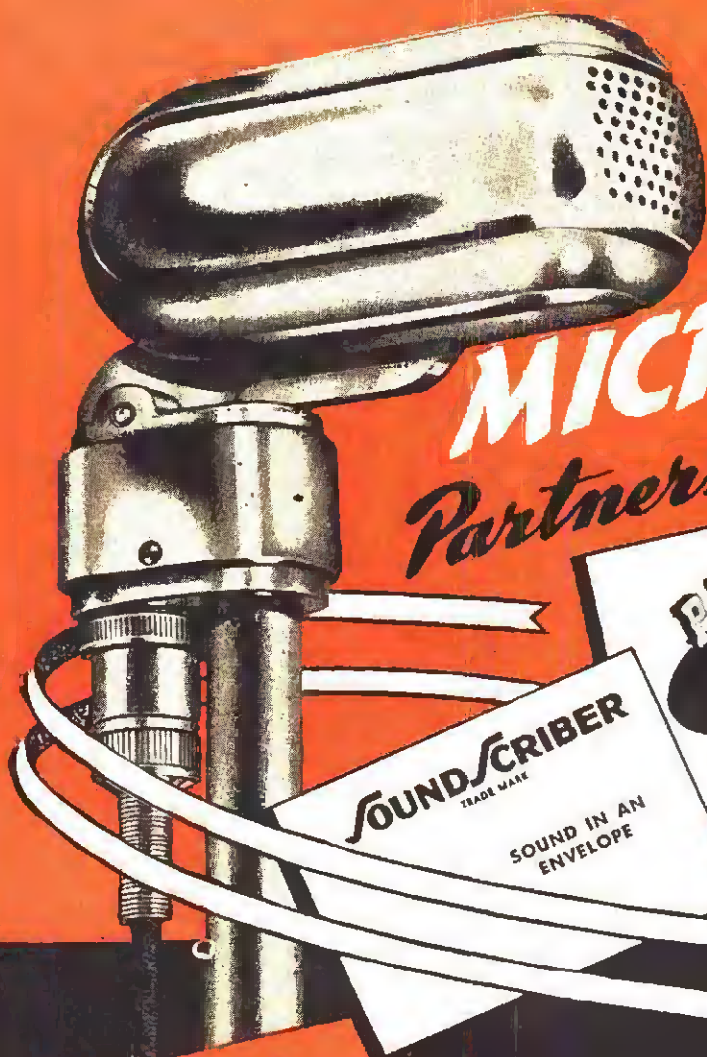

SOUND SCRIBER
TRADE MARK
SOUND IN AN ENVELOPE

PARABLO

MODEL "K" RECORDER



GENERAL ELECTRIC
MODEL 50A RECORDER

TURNER 211 DYNAMIC BROADCAST TYPE

Utilizing a new type magnet structure and acoustic network, Turner 211 extends the high frequency range and raises the extreme lows from 2 to 4 decibels — to compensate for overall deficiencies in loud speaker systems. Unique diaphragm structure results in extremely low harmonic and phase distortion without sacrificing high output level. A reliable unit for use in war plants, P. A. Systems and broadcast studios.

Leading designers and builders of rugged electronic recording devices ally their products with TURNER applications for sure-fire performance under varying acoustic and climatic conditions. Today these recorders play an important role in essential war communication activities. In the world tomorrow, they will open new horizons in the fields of radio, entertainment, education and business.

It's time to Turn to Turner for suggestions and applications in your electronic developments. The clear crisp reproduction of any sound — the rugged construction, accurate response, professional appearance and maximum performance of Turner Microphones give them a prominent position in any microphone discussion. While orders are being filled currently for those whose needs meet priority requirements, Turner invites your inquiry for collaboration with post-war developments.



TURNER — *Pioneers in the Communications Field*

The **TURNER** Company
CEDAR RAPIDS, IOWA

Write for your Free
copy of Turner's
Illustrated Catalog

Crystals Licensed Under Patents
of the Brush Development Company

COMIN' AT YOU!



Buy War Bonds

... and some for all!

Here comes aluminum . . . rolling out to meet the highest *record* demand in its history . . . and back to do a bigger and better job in PRESTO RECORDING DISCS!

PRESTO *ALUMINUM* RECORDING DISCS are now available in all sizes from 6½ inch to 17¼ inch. That's *good news* for broadcasting stations, recording studios and schools all over the nation . . . who know through valued experience that PRESTO is

simpler to handle—doesn't require fussy adjustments . . . and, in fact, is the smoothest cutting disc they've ever used!

Order PRESTO ALUMINUM DISCS from your regular electronics distributor. May we suggest that you split your order—50% aluminum and 50% glass base for the time being, so that we can fairly distribute PRESTO ALUMINUM DISCS over the first big demand?

PRESTO RECORDING CORPORATION

242 West 55th Street

New York 19, N. Y., U. S. A.

Walter P. Downs Ltd., in Canada

Life Testing ON THE GRAND SCALE!



One of the most elaborate cathode-ray tube test racks in this country operates day and night, seven days a week at National Union. For, at N. U., cathode ray tube production is now reaching heights undreamed of in pre-war days. To achieve this production, entirely new testing techniques, on an unprecedented scale, have been developed.

Examples of the newest tried and proven products of National Union manufacture are the four cathode-ray tubes illustrated. All of these N. U. cathode ray types can be produced in a

variety of screen materials, which will have various post-war applications in television and industrial electronics.

Here at National Union are many such ultra-modern products ready for the greater post-war service and replacement needs of your customers. N. U. Tubes for television, FM, AM, receivers, transmitters, and many new household conveniences. Ready from the day our present obligations are fulfilled and reconversion can get under way. Count on National Union.

NATIONAL UNION RADIO CORPORATION, NEWARK, N. J.
Factories: Newark and Maplewood, N. J.; Lansdale and Robeson, Pa.

NATIONAL UNION RADIO AND ELECTRONIC TUBES

Transmitting, Cathode Ray, Receiving, Special Purpose Tubes • Condensers • Volume Controls • Photo Electric Cells • Panel Lamps • Flashlight Bulbs

Selling YOUR Service

Advice to Ease Servicemen's Worst Headaches by Solomon Heller, New York Radioman

• Radio service men have made few efforts to solve their biggest problem: public distrust. Far too many people regard radiomen as dishonest. Since suspicious patrons rarely develop into steady customers, it is obvious that this attitude hurts business.

A great deal of public distrust springs from ignorance. I have met hundreds of customers who believe a radio is made up solely of tubes. Tell customers like these that a condenser or resistance is burnt out, and they give you a long, suspicious look that makes you regret that you ever took up radio servicing.

Many shop around for a serviceman who will tell them they only need a tube. Even when they consent to having their radios repaired, customers like these rarely come back.

What can be done with this type of customer?

Here is one method that brings results: Mount an assortment of the various parts used in a radio on a board. The demonstration boards used by some radio schools are ideal. Display this parts assortment prominently. When the customer sees the many types of resistances, condensers, coils, switches, and transformers that make up a radio, he will be forcibly impressed with the fact that there is much more to a set than just tubes.

To supplement this display, the inside of a large radio chassis might be exhibited, with cardboard markers, mounted on pins, placed at common sources of trouble. These markers might have brief notations, such as: "Switch may short," "Resistance may burn out," "Coil may open" and so forth.

Educate Customers

Educating customers in this way will pay dividends. It will be easy to demonstrate that testing for trouble, rather than repairs, takes up most of the serviceman's time. Most important of all, this display will result in a feeling of respect for the technician who can understand the complicated maze of wires and parts that make up a radio.

Another headache that confronts servicemen is the problem of free services. Some repair shops still offer "free" pick-ups and deliveries, and "free" estimates.

1—Use a demonstration board to show all parts in modern set.

2—Advertise your price policy and don't "pad" bill to hide "free" services.

3—Establish a simple guarantee policy.

4—Do professional service for professional prices, and maintain professional standing.

In my opinion, this is a great mistake.

The service dealer who offers any services free is either taking a loss, or disguising and padding his charges.

If he is taking a loss, he is not a good business man. If he is padding his prices, and concealing the charges for these "free" services, he is not a good business man either. Customers have a way of detecting—and *resenting*—padded prices. The net result is an increase in the public's distrust of radio repairmen in general.

Charge for All Service

This distrust, it cannot be emphasized too strongly, means a business loss for the serviceman. To cite one example: A great many radios are permitted to go on playing, in spite of defects which cry out for repairs, because their owners are afraid of being cheated by the repairman.

The best plan for the serviceman is to charge adequately for every service he renders.

Free estimates give the dealer more of a headache than any of the other free services. Shops that offer estimates free have to accept frequent losses. Since a diagnosis is generally the most difficult part of a radio repair, withdrawal of a set by the owner means that the time spent estimating the repair must be written off on the red side of the ledger. Furthermore, since a policy of free estimates encourages "shopping," the number of withdrawals is increased.

It seems to me that by advertising it should not be difficult to put over the truth: namely, that paid estimates, in the long run, constitute the fairest, most honest, and basically cheapest policy for the customer.

Guarantees constitute a knotty problem for many service shops. Some guarantee only the parts they replace, for a period of ninety days. A limited guarantee of this sort often leads to a lot of trouble later. Customers do not understand the nature of this guarantee. Furthermore, even when they do, they don't like it.

90 Day Guarantees

They resent paying two or more repair bills within a three-month period, and will usually stay away from a shop which imposes such charges.

Other servicemen guarantee to replace all parts free during the 90-day period, with the exception of major units, like loudspeakers and power transformers, as well as tubes. This is a more satisfactory procedure from the customer's point of view. Still, payment of extra charges during the guarantee period is not ruled out, and may cause a certain amount of ill-will.

Probably the best plan would be to guarantee repaired sets unconditionally for ninety days. Customers would not be charged for any repairs or replacements, including tubes, that might prove necessary during this three-month guarantee period.

In a small percentage of cases, such a practice would undoubtedly mean a financial loss. Such losses, however, could be compensated for by revising the schedule of prices slightly upward the year following.

Suppose \$50 had been spent in unpaid-for replacements of parts, tubes, etc., during the course of a year. If an average of 500 sets were repaired yearly, ten cents would be added to the repair bills of the next year, wiping out the loss.

This unconditional guarantee policy would thus pay its way. The confidence and good-will gained by such a policy would be tremendous.

A business-like price policy would involve, first, the formulation of adequate rates. The charge for each repair would be proportioned to the

(Continued on page 88)



**TIME
IS SHORT**



THINK



PLAN



**ACT
TODAY**



◆ **PATTERN FOR RADIO PROFITS** ◆

Yes, the Clarion Radio dealer set-up IS different. It's the talk of the industry. The biggest Clarion feature of all will be found in the Clarion dealer franchise. It will pay you to investigate before it is too late. Write TODAY for name of distributor in your territory.

WARWICK MANUFACTURING CORPORATION
4640 WEST HARRISON STREET . . . CHICAGO 44, ILLINOIS

THIS PIVOT PROVES A POINT

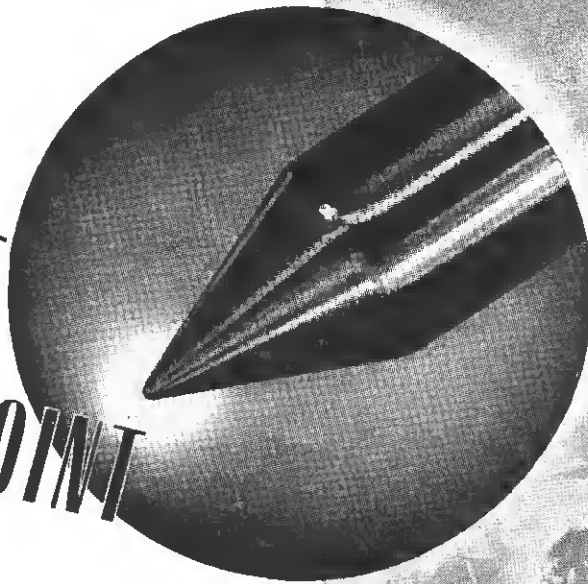

THIS unretouched photomicrograph, approximately 50 times actual size, shows pretty clearly what we mean by the value of experience, when it comes to the making of electrical instruments and testing equipment.

Pivots play an important part in determining an instrument's life and accuracy. In the Simpson-made pivot above, you have what is truly a masterpiece of its kind . . . perfect in contour . . . all surfaces brilliantly polished to prevent rusting . . . rounded end properly correlated with radius of jewel to minimize friction and withstand vibration and shock . . . heat-treated for an unusual combination of strength and hardness.

The obvious explanation for this excellence rests in the fact that Simpson employs some processes others do not, and safeguards every step of manufacture by the finest and most complete control modern science can provide. But in the final analysis, it is only Simpson's long experience which makes such a pivot possible.

That experience reaches back more than 30 years. From it has come new shortcuts in manufacture, new refinements in design, which today permit Simpson to make "instruments that stay accurate" in greater volume than ever before. From this long specialization has come too a sound basis for further advance; in your postwar Simpson Instruments you will see still more forcefully the value of this experience.

SIMPSON ELECTRIC CO.
5200-5218 Kinzie St., Chicago 44, Ill.

Simpson

INSTRUMENTS THAT STAY ACCURATE

Buy War Bonds and Stamps for Victory

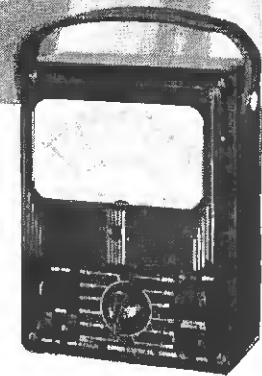
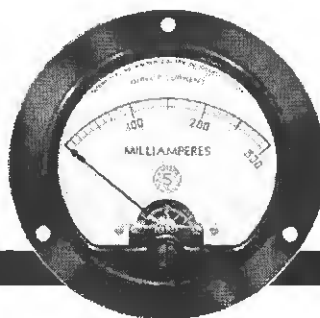
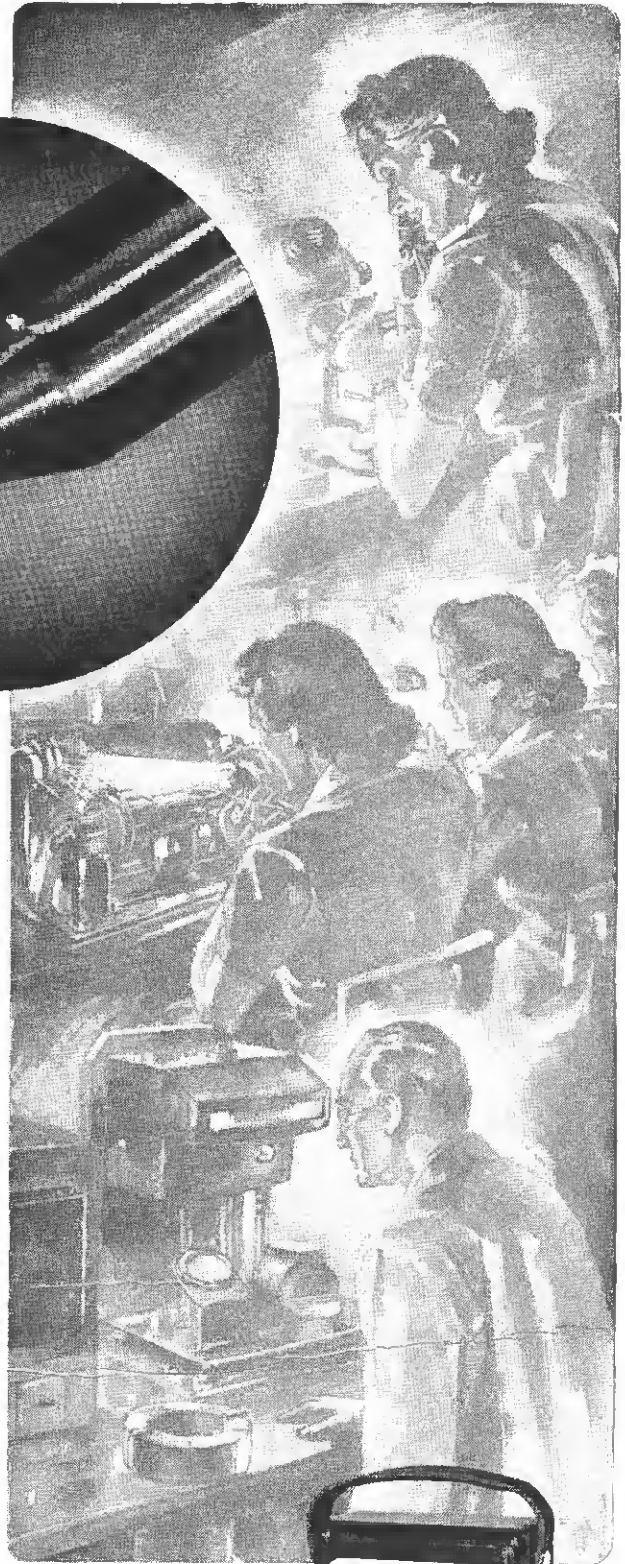

6 out of every 10 persons say television pictures of present-day clearness are acceptable to them and they will not delay purchase after victory, waiting for improvements to come along.

4 out of every 10 persons say they plan to buy a television receiver *as soon as sets are released for sale after the war.*

6 out of every 10 persons not planning to buy immediately after the war say they expect to buy *within 3 years.*

8 out of every 10 persons have already witnessed a television program on a television receiver set. (3 stations are telecasting in the New York area.) The Public wants Television! We believe it will be agreeably surprised, for while war halted Television expansion, it did not halt DuMont research. A vast

improvement over present-day video telecasting and reception waits only on the lifting of war restrictions on materials. DuMont contributions to this advancement are fascinating and impressive!

DuMont national advertising is intensively cultivating your postwar television market for you — in ads that whet desire for fine quality receiving sets embodying the best in engineering performance and artistry; sets that are profitable to handle, the kind that DuMont will build. When DuMont resumes manufacture, its line will be complete, including radio and phonograph combinations. And to bulwark DuMont prestige, we plan to establish technical training schools for television service and repair men so that DuMont distributors and DuMont dealers will be able to assure their customers satisfaction.

• 6 out of 10 Will Buy Television

Here are the highlights of a Television Survey just completed for us in residential suburbs surrounding New York City. We know you'll find them interesting . . . as these results may reflect buying opinion in metropolitan areas generally. The Public wants Television!



Copyright 1944, Allen B. DuMont Laboratories, Inc.

DUMONT



Precision Electronics and Television

ALLEN B. DUMONT LABORATORIES, INC., GENERAL OFFICES AND PLANT, 2 MAIN AVENUE, PASSAIC, N. J.
TELEVISION STUDIOS AND STATION W4BD, 515 MADISON AVENUE, NEW YORK 22, NEW YORK

Distributor Activities

Zenith Names Sues-Brown For Los Angeles Area

The question of who would get Zenith Radio Corporation's much sought after Los Angeles distributorship has been answered by the announcement of H. C. Bonfig, vice-president in charge of household radio, that the franchise has been awarded to the Sues-Brown Co., Los Angeles.

Sues-Brown is a newly formed partnership, Bonfig said, organized specifically for the purpose of distributing Zenith radios. The principals are Melvin ("Pete") Sues, who since 1934 has been vice-president and general manager of the Los Angeles branch of the Leo J. Meyberg Co., distributors for RCA in California; and Clarence Brown, an executive of Metro-Goldwyn-Mayer.

Mr. Sues will act as general manager. "Since our company was seeking outstanding experience in the field of radio distribution, it would be difficult to find a better working team anywhere than Pete Sues and Clarence Brown," said Bonfig.

Bruno-New York Names Heads of Departments

Irving Sarnoff, vice-president of Bruno-New York, Inc., Victor and RCA Victor distributors for nearly a half century, in a letter to dealers, has announced the following department heads:

Gerald O. Kaye, sales promotion manager and merchandising assistant to Mr. Sarnoff; Ira M. Schwartz, sales manager of Bendix automatic home laundry equipment; Philip Silverman, sales manager of Victor and Bluebird record division, and Dave Wagman, sales manager of RCA Victor radio and tube division. Mr. Kaye has been with the company since 1936; Mr. Schwartz since 1937 and Mr. Silverman joined the organization in 1923. Mr. Wagman has been an executive with a large wholesale radio company and has been directing distributor sales since 1923.

Bruno-New York also distributes vacuum cleaners, ironers, washers and has recently announced its postwar lines will include kitchen cabinets, space heaters and General Electric small home appliances.

Herman Goes Super Market

The Herman Radio Supply Co., in its new location at 1745 E. 2nd Ave., Miami, Fla., has set up a super self-service market for the sale of parts, according to an announcement made by Harvey Herman, head of the firm.

HATRY



. . . . And YOUNG



Above, Louis W. Hatry, and, below, Nicholas T. Young, radio-electronic distributors, 203 Ann St., Hartford, Conn., are celebrating their 16th anniversary as wholesalers.

Crosley Names Superior

The Superior Distributing Co. has been appointed to wholesale Crosley products in eastern Kansas and western Missouri.

Ohio Jobber Stresses Sales Success Factors

Owen Smith, president of the Warren Radio Co., Toledo, Ohio, whose branch at Lima, Ohio, is managed by J. W. Hutchinson, well-known in the radio field, has some original thoughts on operating a distributing business. Says Mr. Smith:

"It's not the size of the town or the competition that counts, it's your manpower and management, the trading area, your methods of doing business, and the carrying of adequate stocks of nationally advertised standard brands of merchandise. Along with this, give quicker and better service and you'll get the business."

Southern Radio Corp. is Optimistic on Future

James P. McMillan, general manager of the Southern Radio Corp., 1201 W. Morehead St., Baltimore, Md., was named president and treasurer of the company at a meeting of the company's stockholders and directors.

The Southern Radio Corp., recognized as one of the largest distributors in the South, handles RCA radios, phonographs, and records and other products, including a new line of refrigerators, automatic washing and drying machines, home freezers, etc. It has 1,000 dealers in North and South Carolina. The company was organized in 1930, later absorbing the Baltimore Distributing Co., which handled the Victor Talking Machine Co.'s products in this area. Lt. (jg) Fred M. Laxton is vice-president of the company and J. M. Oldham is secretary.

One of the brightest phases of the future radio business, Mr. McMillan says, is frequency modulation and television. He believes that in the first year of the post-war period FM radio will sweep the country with television following closely.

Goldman General Manager Of Arvin-Salmanson

David F. Goldman has been appointed general manager of Arvin-Salmanson Co., of New York, Inc., and Arvin-Salmanson Co., of New England, Inc., according to an announcement by Sam Salmanson, president of both companies. The firm will distribute Arvin radios and electrical appliances manufactured by Noblitt-Sparks Industries, Inc., of Columbus, Ind.

Mr. Goldman is nationally known in the radio and electric appliance distribution field. For a number of years, starting in 1923, he was general manager of the North American Radio Corp., which was very active in the Metropolitan New York market distributing leading lines.

In 1935 he associated himself with Trilling & Montague, large distributors of major lines in Philadelphia, and as general sales manager of that company for the last 9 years, has had a very successful sales record.

New Motorola Distributor

Jones-Cornett Electric Co., Welch, W. Va., has been appointed to distribute products of the Galvin Mfg. Corp., in the West Virginia area.

(Continued on page 98)



Yes—

MR. RADIO DEALER

it will certainly pay
you, at war's end, to

"TEAM UP!"

with



TEMPLETONE RADIO COMPANY, Mystic, Conn.

FM ... Television ... Radio-Phono' Combinations

WHERE FM WILL ALSO MEAN FINEST MADE!

Licensed under Armstrong and RCA Patents

Electronic Expert

Reading, Pa., Specialist Plans Big Future in Industrial Repairs (See also Front Cover)

• The co-owners of Western Radio Service, 36 S. Fifth St., Reading, Pa., are another example in the radio field that war can be an interruption but not a permanent set-back! RADIO & Television RETAILING's representative found Paul Reed, temporarily the remaining partner to run the business, in his small but well laid out shop in an active section of Reading.

Reed's partner, Robert M. Smith, is now with the Army Signal Corps. Smith's bench, however, is just as he left it (see photo below). We have taken a picture of it, even though its operator is not present, as we believe other radio servicers will be interested in seeing its unusually compact arrangement. It was built entirely by its owner.

Paul Reed carries on in the absence of his partner with the undaunted enthusiasm of a man who thoroughly knows his subject.

Formerly with a parts and tube distributor, and one-time radio troubleshooter for one of the large radio manufacturers, Reed went into business as an individual service dealer and finally joined forces with Smith. They have been doing a large business in auto radio repair, and in this work they require all chassis to be brought in separately, as they find removal and installation require too

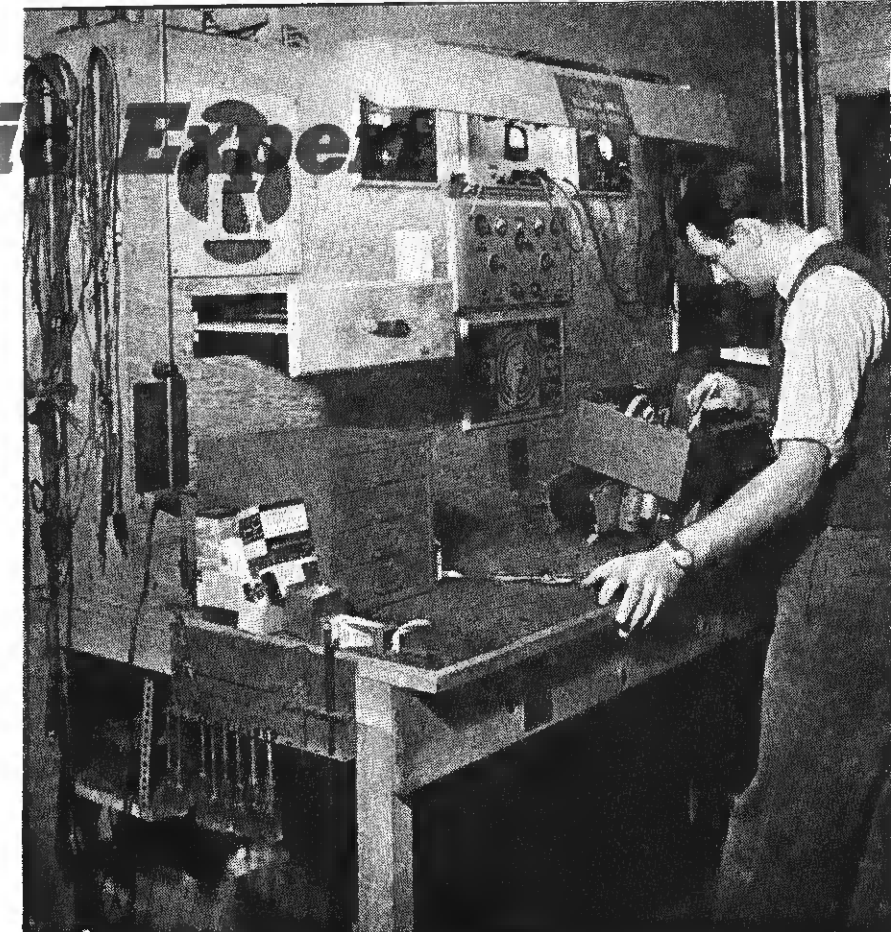

Troubleshooter Paul Reed diagnosing the cause of intermittent operation.

much time. In this connection they recommend a nearby garage.

The current demand for radio service is heavy and Reed has restricted outside calls to two days a week. During the rest of the week, work is brought into the shop by customers.

Servicer Reed uses as many short cuts as he can feasibly make use of and still do a top-notch job of repair. When needed new parts are not available he uses rebuilt parts from a nearby reliable source which specializes in this merchandise, and Reed finds this a timesaver. Reed believes

the oscillograph more useful in experimental work and not fast enough for the average job of servicing. His bench, shown at upper right, holds equipment most of which he built.

Vitally interested in the future of electronic maintenance, Reed keeps at the head of developments in this field today. His specialty is in the repair of automatic photo printing machines.

Electronic Maintenance

These machines utilize a photo-cell and amplifier, and are subject to the usual troubles affecting amplifiers, such as condenser breakdown, etc. When the coupling condensers in these circuits break down, the exposure time of the print is thrown off. This can't be tolerated in the mass production of photos which these people are interested in.

Western Radio Service also does a good job on the repair of sound equipment and moving picture projectors, as well as on a local war plant's automatic welding control timers. Another of Reed's specialties is repair of juke box amplifiers. Postwar, when Smith returns, Western Radio Service will stock parts and tubes and records. They do not plan to specialize in radio set sales, but will continue to be electronic maintenance specialists.

Smith's bench awaits his return.

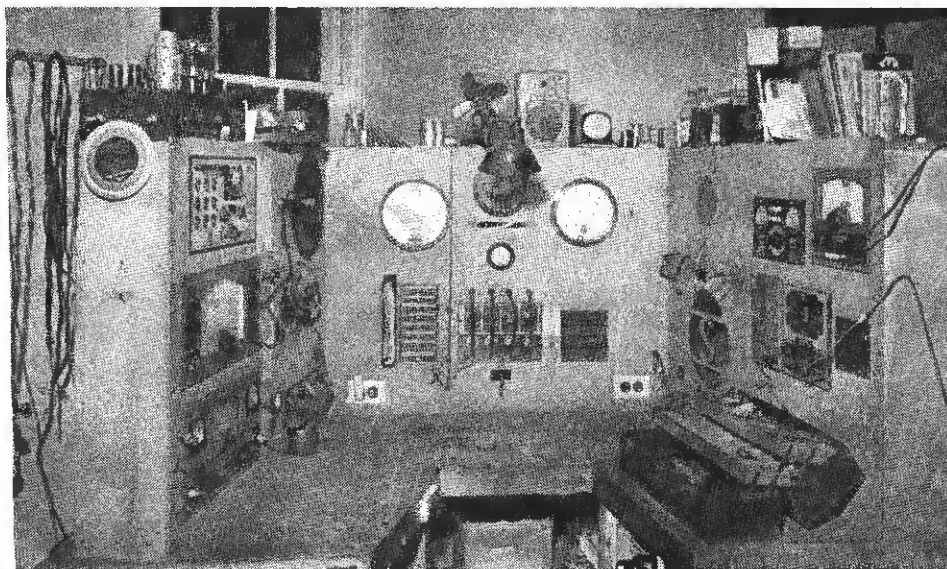



It's a "Double Blessing" for the Dealer with the Majestic Franchise!

THE FAME OF A NAME

Just how famous is the name Majestic?

Consider these results of a survey conducted by the Ross Federal Research Organization in 17 typical cities—

Thousands of men and women were shown cards bearing the one word—*Majestic*. Asked what product they associated with this name, more than 45 out of every 100 replied—*Radio*.

Nor is this all. When those who could not answer the first question correctly were asked whether they had ever heard of Majestic Radio, 43 more out of each original 100 replied—*Yes*.

Thus, 88 out of every 100 persons interviewed—the exact percentage was 88.2%—were entirely familiar with the name *Majestic Radio*.

"It's a blessing" for the Majestic Dealer: He has a *name* to sell that is already familiar to practically every person who walks into his store!

THE POWER OF A PLAN

And just how powerful is Majestic's Controlled Distribution Plan?

Well, what do *you* think of a plan designed to give dealers full protection on the Majestic line against the price trimmers, the "sell-it-to-you-at-wholesale" lads, and all the others who all too often in the past have taken the profits, as well as the joy, out of radio-retailing? What do *you* think of a plan that assures every dealer franchised to handle the Majestic line of radios and

radio-phonographs a fair chance for a fair profit on every sale?

Yes, once more "it's a blessing" for the Majestic Dealer: he has the benefits of a *plan* that aims at putting the radio business on the sound, solid basis where most dealers have always wanted it to be—on a basis where every sale can mean, not simply more volume, but more *profits*, too!

* * *

Would you like to share in the volume *and* the profits that Majestic Dealers are going to win through the "double blessing" of Majestic's *fame of a name* and *power of a plan*?

Then let's hear from you today? We'd like to have you know *all* the reasons why—

Majestic Means Business . . . and lots of it!

Majestic
MIGHTY MONARCH OF THE AIR
RADIO TELEVISION ELECTRONICS

OUR POST-WAR PLAN FOR THE RADIO AND ELECTRONIC INDUSTRIES

Ward Leonard products will soon be available for civilian use. The changes the war has made in electronic devices is bound to be evident in the distribution of electronic components due to new hook-ups, new application, new equipment to service. To ren-

der a complete service to this field, Ward Leonard have appointed Ken Hathaway as Manager of their Radio Distributor Division. He will be located in their Chicago Office. Distributors' literature now in preparation—get your request in NOW.

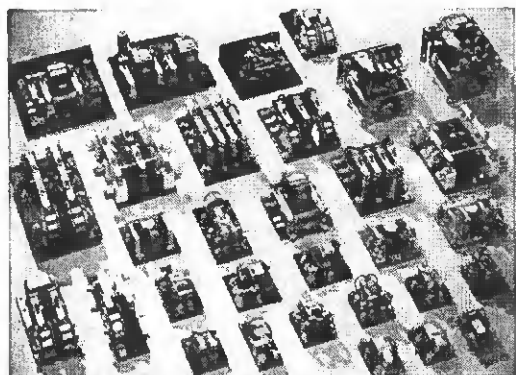

RELAYS

The Ward Leonard Line of Relays comprises light, intermediate and heavy duty types for sensitive, transfer, time delay, antenna change-over, break-in, and latch-in operation. They all have crisp action, are dependable and durable. Ward Leonard Relays use but little power.

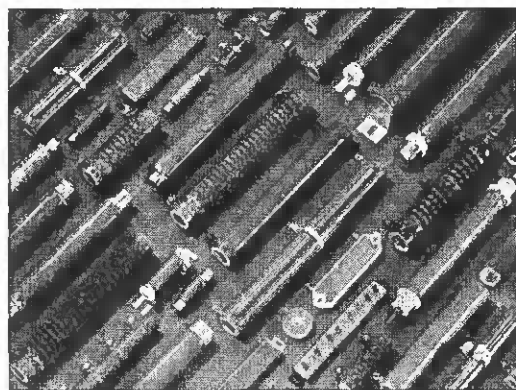

RESISTORS

Ward Leonard Resistors are built to withstand heat, moisture, vibration and other adverse operating conditions. The regular line covers a wide range of types, sizes, ratings, terminals, mountings and enclosures. You can find exactly the resistors you need in the Ward Leonard line.

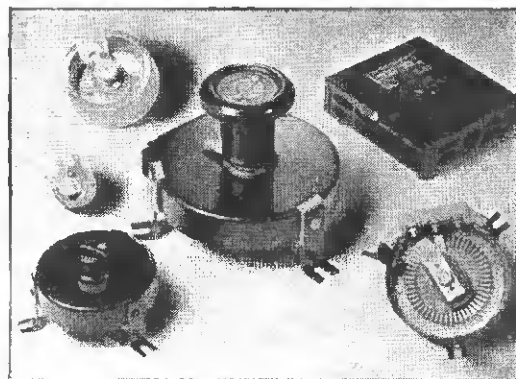

RHEOSTATS

Ward Leonard Rheostats include the widest range of sizes, tapers and current ratings from the tiny ring types for radio to huge multiple assemblies for the heaviest industrial use. Smooth operation, durable contacts and extreme dependability characterize all Ward Leonard Rheostats.

WARD LEONARD

Electric control  devices since 1892.



WARD LEONARD ELECTRIC CO., Radio Distributor Division

53 WEST JACKSON BLVD.

CHICAGO, ILL.

1895

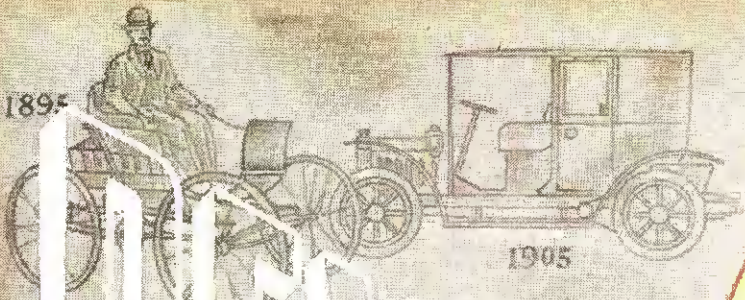

1905



1910



1915



1926



1932



1942

Development!



WARD LEADS THE WAY in the Antenna Field . . .

THE WARD PRODUCTS CORPORATION has long been the leader in the design and manufacture of antennas for automobiles and home radios. Since its beginning WARD has been the recognized pace-setter. Many important design changes, pioneered by WARD, have become accepted standards in the industry. All products bearing the WARD name are quality products, workmanship of craftsmen using modern equipment under ideal conditions. For finest antennas for all automobile and home applications, look to WARD!

WARD



Antennas



BUY WAR BONDS

THE WARD PRODUCTS CORPORATION
1523 E. 45TH STREET • CLEVELAND 3, OHIO

Veteran dealer Ulerich of Indiana finds that his repair service furnishes him with innumerable leads to help increase his major appliance sales.



Repeat Sales Result From Merchandising at Home and on Farm

Sell as You Service

• Robert F. Ulerich has operated the Ulerich Electric Shop in Columbia City, Ind., for 16 years. During that time he stocked and sold a complete line of electrical home appliances in connection with a repair and service department, which includes wiring homes, business and farm buildings. Significantly, Ulerich declares that repair service was the main factor in helping him to sell major units and accessories in normal times.

For example, in an area of approximately 4,300 people, he sold 250 refrigerators, 125 electric ranges, 75 washers, and 100 radios in the peak year of 1941, before the restrictions.

Service Yields Income

Mr. Ulerich explained that his chief source of income since major appliances were "frozen" has come from servicing the hundreds of major units he sold in the past. Now, Ulerich is getting ready to resume connections with his former appliance suppliers to insure his customers getting the quality they expect.

He will, for example, continue with the full line of Westinghouse appliances, and Kelvinator refrigerators. He will handle Zenith radios, and will stock the Sunbeam line of irons, mixers, etc.

The easiest sales and the ones most satisfactory to the buyer and seller alike are the ones he makes in the field while fixing a range, or adjusting a radio, or some other appliance he has sold.

On one service trip, Mr. Ulerich closed a deal for a new electric washer, and a console radio. As

Ulerich put it, "These are the very best contacts you can make, and there is no quibbling about prices. You have already convinced your customers that you can and will keep the appliances in perfect operating condition. These are always good sales to make."

New Prospects

In normal times, Mr. Ulerich says there are enough service calls to keep good customers lined up for their additional major appliance requirements. From these personal calls, most repeat orders are obtained. Here, too, are obtained the liveliest prospects for more *new* business. Prior to the war, Mr. Ulerich employed enough salesmen to cover his territory besides what selling he could do himself on his personal service calls.

Another factor which helped him build up the large amount of appliance sales and service accounts was in selling the housewife the size of unit she *needs*. His refrigerator sales in 1941 were mostly in 7 ft. units, with a considerable number of 9's. At first a few people said he was high-pressuring them. He sold a 9 ft. refrigerator to one farm lady who immediately protested that he oversold her. But six months later she thanked him profusely for selling her the larger size.

Mr. Ulerich pointed out that he first made the mistake of selling a range or refrigerator which the customer *asked* for, only to find later on that the customer was *wrong*—her estimate of what she needed was entirely too low, and most people nowadays *need* a larger refrigerator, especially in rural homes. This also

applies to other units, ranges and water heaters especially. People want better radios too. Out of the 100 radio sets sold during 1941, the major percentage were in the higher price bracket.

People soon learn that you know the appliance business, and can be counted on to provide the right type and size of units needed, and to service them adequately. That, Mr. Ulerich pointed out, is what helped him most to build up a profitable repeat business.

Dealer Ulerich believes the biggest after-the-war sales will be in freezing units for rural communities, and with missionary work, many urban sales will be a potential. He intends to go after the development of this latter market.

Farm Markets Important

Second in sales volume will be washers and radios. Radios, of course, will also be at the top, says Ulerich. Ulerich, however, is not overlooking the voluminous prosperous farm market. Without electric milking machines, washing machines, electric refrigerators, and scores of other labor-saving devices the vast food-for-victory program would have been defeated.

To illustrate farm needs further for the postwar era, Mr. Ulerich went on to say that all farmers on established high-lines want more labor-saving devices. Those who fought electric power before the war now are asking for electric power extensions as soon as conditions will permit construction. This means more sales to fill an increased range of needs.

Delco Radio Products *Mean Dependability*



All over the world Delco Radio products are in useful service. They prove daily that the name Delco Radio means dependability . . . dependable designs developed with care and imagination; dependable products built with craftsmanship and skill. In radio and electronic equipment, the name Delco Radio stands for engineering vision—manufacturing precision.

MAKE YOUR DOLLARS FIGHT—BUY MORE WAR BONDS

Delco Radio
DIVISION OF
GENERAL MOTORS

NEDA's Barbey keeps an active hand on the wheel of Washington's programs for the industry. He championed the jobbers when things looked black.

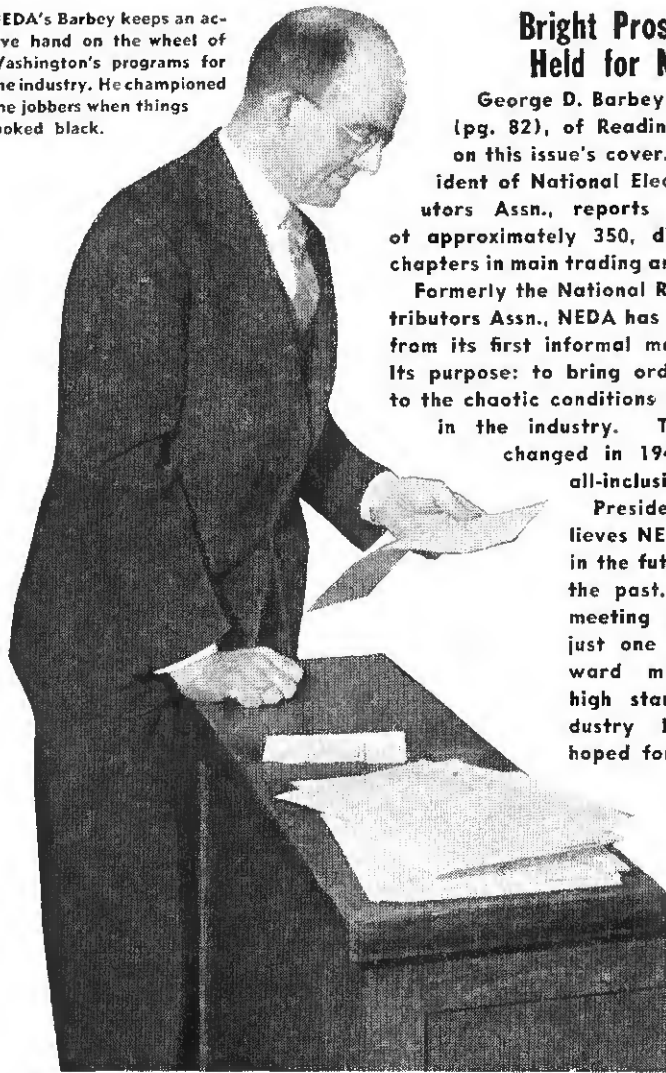

Bright Prospects Held for NEDA

George D. Barbey and Paul Reed (pg. 82), of Reading, Pa., appear on this issue's cover. Barbey, president of National Electronic Distributors Assn., reports a membership of approximately 350, divided into 24 chapters in main trading areas of the U.S.

Formerly the National Radio Parts Distributors Assn., NEDA has grown steadily from its first informal meeting in 1937. Its purpose: to bring order and clarity to the chaotic conditions then prevailing in the industry. The name was changed in 1942 to make it all-inclusive.

President Barbey believes NEDA will flourish in the future as it has in the past. This month's meeting in Chicago is just one more step toward maintaining the high standards the industry had originally hoped for.

Horoscope

(Continued from page 65)

ference of housewives to get pointers on future features for roasters.

The electric clock went to town for the dealer. This item is generally accepted, cheap to operate and colorful as display.

Hand Irons: Always a good sales item, the electric hand iron, automatic and non-automatic, is profitable, easy to sell and fairly service-free. Pre-war prices, reliable makes, \$2.95 to \$9.95.

The Steam Iron, shorn of its bad features, will go over big, probably at prices between \$5 and \$18.50. Fingertip control of steam is feature operators demand, since this eliminates necessity of using two irons.

Selling Your Service

(Continued from page 76)

time spent on it, and would cover the cost of the materials used, fixed overhead and labor costs, and a fair percentage of profit.

A country-wide survey made just before the war indicates that the majority of radio service dealers place a very low value on their skill. Here are some of the statistics:

Number of sets repaired per year by average serviceman	500
Average repair charge	\$4.00
Average cost of materials per repair	2.50
Average profit per repair. . . .	1.50
Gross yearly income of the average service dealer. . . .	2000.00
Net weekly income of the average service dealer	27.00

In these war-boom days, of course, service income has gone up. After the war, however, income from radio service will no doubt take a downward plunge, stabilizing itself at the pre-war \$27 per week level—unless radio servicers reach some agreement on establishment of minimum prices, and the abolition of free services.

Fighting competition by cutting prices benefits none of the competitors. Any temporary advantage is nullified by the permanent disadvantages.

Radiomen deserve a professional standing, and a salary commensurate with their skill. Only when they realize their worth, will they be able to impress it on the public, and rise forever out of the \$27 per week class.

Donaldson's

(Continued from page 37)

Cards on incoming sets give name, address and ailment as described by clients. The customer is given an identical stub of this card. The information on the card is then recorded, alphabetically, in a ledger with the card number, owner's name, etc., and the radio takes its place in line.

When the job is finished, the stub is torn off the radio and brought to the office, and it now gives the shelf number and the work done. The amount of the bill is then recorded in the ledger alongside the other data, and the shelf number copied from the card. When the customer calls, the clerk looks at the ledger, and is able to go instantly to the shelf containing the radio.

Eight former employees of the plant are fighting on various fronts for their country. These men will be given jobs as soon as they return. In the meantime, part of the work

load these men left is being carried by what Donaldson refers to as his "junior employees." These are young men who have a yen to become service experts, but who lack sufficient training and experience.

Apprentice System

Some of these apprentices are graduates of radio training schools and some are just born tinkers who want to make a career of radio repairing. In the beginning there were six of these youngsters, but two have already graduated into full-fledged radio repair berths. Donaldson is secretly very proud of the way these youngsters fit into key spots on the staff. The apprentice system was a wartime measure, but this dealer says it is here to stay.

C. W. Donaldson is preparing to go places after the war! Of course, his associates in the field might tell you that the firm has already been places. But the shop is widening its field for the future.

Travel with Trav-ler

"Actually!... you'd think you were in the studio!"

Every note coming through the new postwar Trav-Ler is so clear and lifelike that *listening is like traveling* to the broadcast... like having a seat right down in front row, center.

This amazingly realistic reception, in both AM and FM, will be the big selling feature of Trav-Ler Radios... even ahead of their eye-appeal and low price.

Future-minded dealers and distributors are invited to inquire about postwar Trav-Ler Radios and Karenola Record Players.

TRAV-LER KARENOLA RADIO & TELEVISION CORPORATION

1028 24 W. VAN BUREN STREET CHICAGO 7, ILL.



Karenola
RECORD PLAYERS



"Swing's The Thing"
Hoard on W-G-N

Television Talk

Broadcasters, Manufacturers, and Dealers Enthusiastic Over Tele's Future

DuMont WABD Opens New Video Studio in New York

DuMont Television Station WABD in New York has opened a new studio and expanded facilities.

In addition to the original studio on the 42nd floor of 515 Madison Ave., alongside the transmitter, movie projection room, laboratory and other quarters, the station now occupies the second floor for its new large studio, two reviewing rooms, a theatre with projected screen images, general offices, dressing rooms, prop room and other accommodations. A sales department for television equipment will be on the third floor.

The new studio was officially opened on September 17, followed by an informal reception and housewarming party on the following Thursday, attended by representatives of the radio and television, advertising, theatrical, banking, press and other fields.

More Licenses Sought

The Columbia Broadcasting System has filed applications with FCC for licenses to operate television stations in Boston, Chicago, Los Angeles and St. Louis.

Dealer Keeps Customers "Television-Minded"

The man in the street is wondering about television, and the dealer who can answer his questions now, is the dealer who is going to supply him with sets later. Buring's Radio, 1850 Erie Boulevard, Syracuse, N. Y., is completely sold on the policy of publicizing television activities to insure future sales.

Buring conducts forums, demonstrations, and sponsors a radio show on television. His newspaper ads usually carry a television plug such as "Hear your favorite recording artists now, see them on a television set from Buring's after the war."

Novel Question Hour

His customers know that each Saturday afternoon is Buring's television questioning time. Buring keeps up on the various aspects of television by reading everything from technical magazines to the daily paper.

This weekly question and answer session also enables Buring to overcome the reluctance some customers have about buying a high-priced console job now, fearing it may become obsolete in a few months. He has a number of such console radios in stock, and to boost sales Buring uses window displays and charts showing the number of months it will take the leading

radio manufacturers to get into full swing production on television receivers.

Buring asks customers to fill out short forms on which they list the types of television programs they would like to see most in their own homes. Buring goes over these forms and announces the results in a window poster. This is one of the many promotion schemes he believes keeps his customers television-minded.

Sees Tele Bridging Language Barriers

Television is a medium which bridges the barriers of language and thus should be an important contribution to the growing friendship between the countries of North and South America, Dr. E. F. W. Alexanderson, radio pioneer and consulting engineer of General Electric, told a delegation of Mexican government officials visiting Schenectady to witness a special performance of television at WRGB.

"Here in Schenectady we look upon television not just as local entertainment, but as a new medium of communication, which will eventually extend over the continent and the two continents of North and South America," Dr. Alexanderson said.

"The chain of television, which includes Schenectady, New York and Philadelphia, is a beginning of this. We foresee the development of a chain of relay stations touching every large community, and

there is every reason why these relay chains should be extended into Latin America.

"Television is a medium which bridges the barriers of language, and when we in a not too distant future are enabled to see on our television screen what is happening in the countries of our southern neighbors, and vice versa, we feel sure that this will contribute to our growing friendship."

TBA Plans December Conference in New York

Plans have been made for the first annual conference of the Television Broadcasters Assn., to be held December 11 and 12, at the Hotel Commodore in New York.

O. B. Hanson, general chairman of the coming event, has announced that the following will head the conference committees:

Reception—Robert L. Gibson, chairman; L. S. Shugg, co-chairman.

Speakers—Allen B. DuMont.

Displays—James McLean, chairman; T. J. Bernard, James Shouse, Leonard Cramer and James Carmine, co-chairmen.

Budget—Douglas Day, chairman; F. J. Bingley, co-chairman.

Awards—Paul Raibourn.

Program—Worthington Miner, Ralph Austrian and William Morris, co-chairmen.

Panel Meetings—Dorman D. Israel.

Publicity—Will Baltin.



Fix these words in your mind:

Zenith Specializes in "RADIONICS EXCLUSIVELY"



**This Zenith Policy
is your assurance of the World's Finest
in your coming New Radio**

SAY THAT WORD, "RADIONICS" out loud. It sounds just like what it means... a compound of radio and electronics which includes many new, secret developments born in the heat of wartime necessity.

It's a broad field, RADIONICS. A field so revolutionary and fast-moving that it requires complete concentration to remain its master. That's why Zenith specializes in "RADIONICS EXCLUSIVELY." No spreading out into unrelated fields like refrigerators, washers, electric irons, cooking ranges and vacuum cleaners. Zenith has no intention of competing with lifelong specialists in those fields.

This policy of "RADIONICS EXCLUSIVELY" has made Zenith one of the largest Radio manufacturers in the world.

It is the reason why millions of owners of pre-war Zeniths are still enjoying top radio performance with least service expense.

And it is the reason why today, down vast Zenith production lines, flow record numbers of superbly performing Radionic devices for the armed services—many of them so "hush-hush" they can only be hinted at. They are not only helping to save lives and win battles

but they are also doing their jobs under the most severe fighting and weather conditions.

So, OUT OF war's proving ground—out of Zenith's background of "RADIONICS EXCLUSIVELY"—will come the finest in radio for you. For through unrivaled war work and years of experience in "RADIONICS EXCLUSIVELY" Zenith has...

ZENITH RADIO DEALERS!

This is one of more than 98 million Zenith Radio messages in leading magazines and newspapers this month. This national advertising program—the biggest in Zenith Radio history—is telling your customers why Zenith's policy of "RADIONICS EXCLUSIVELY" promises the best of radio in coming new Zenith Radionic models.

ZENITH RADIO CORPORATION, Chicago 39, Ill.
All Production Now for War or Rehabilitation

COPYRIGHT 1944. ZENITH RADIO CORP.

Keep Your Eye on **ZENITH** for the Best in Radio!
LONG DISTANCE RADIO
RADIO · FM · TELEVISION · RADAR · SHORT WAVE · RADIO-PHONOGRAPHS · HEARING AIDS
RADIONIC PRODUCTS EXCLUSIVELY—
WORLD'S LEADING MANUFACTURER

Phileo Production Up

The production of war material for the Army and Navy, including radio and radar equipment, manufactured by Phileo Corp., increased 50 per cent in the first six months of 1944, as compared with the corresponding period last year, according to John Ballantyne, president.

Named by Hallcrafters

Glenn May, wounded Marine Corps veteran, has been appointed assistant engineer in the production department of the Hallcrafters Co., Chicago manufacturers of the famous SCR-299, mobile radio communications unit and other short-wave radio equipment.

Provost Marshal Honors Zenith



For outstanding performance in military plant protection, Zenith Radio Corp., was awarded green and gold Military Police Guidon by Major Weber of Provost Marshal's office. Left to right, Capt. H. A. Nealis, Zenith, Capt. E. H. Sherwood, Hugh Robertson, Zenith executive vice-president; Capt. John J. Walsh, Chicago police; Chief James L. Mooney, Zenith; Major J. R. Weber and Capt. Ross L. Stockman.

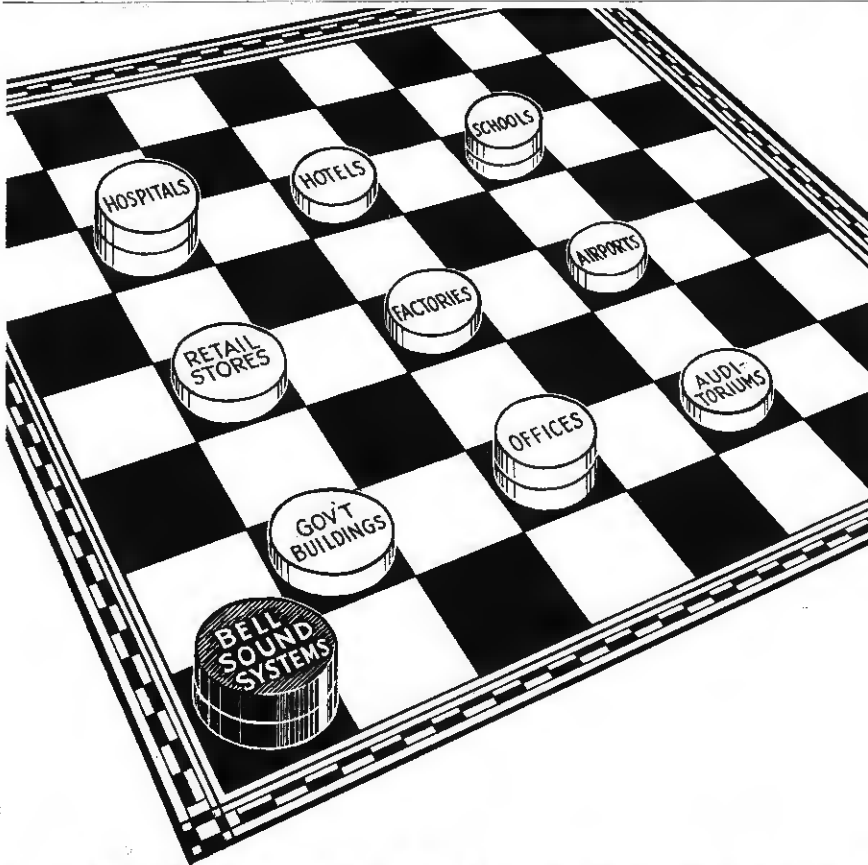

Get them ALL in one move!

The evidence is all in your favor—post-war demands for sound equipment are going to be many times greater than at any time before! New "sound" developments and applications springing from military and war-production needs will be carried over into almost every peacetime commercial, industrial and governmental activity. And *you* can corner your full share of this profitable business if you make sure *now* that you'll be ready with a complete line of top quality, correctly-priced sound equipment. Get the jump on competition today by sending for latest information on BELL Sound Systems! The big job BELL has been doing on a wide range of wartime sound

needs makes them better prepared than ever to do a *big* job for you! Write today.

Bell Sound Equipment Includes—
 Intercommunicating Systems . . .
 Industrial Voice-Paging and Broadcasting Equipment . . .
 Permanent and Portable Amplifying Systems . . .
 Recording and Disc-Playing Units . . .
 Electronic Controls . . .
 Operating Sequence Recorders . . .
 Other Electronic Devices.

BELL SOUND SYSTEMS, INC.
 1186 Essex Ave. Columbus 3, Ohio
 Export Office: 4900 Euclid Ave., Cleveland 3, Ohio



Important Purchase by Rauland Corporation

Announcement is made by the Rauland Corp., of Chicago, of recent purchase of the Phototube division of GM Laboratories, Inc., Chicago.

Identified by the well known trade name, "Visitron," this high quality phototube line comes to Rauland with a background of pioneering history. As long ago as 1925 when sound-on-film was in its early stages, "Visitrons" were used by such pioneers as Dr. Lee De Forest, and at that time were the only cells manufactured on a commercial scale.

Since that time, "Visitron" phototubes have been consistently improved by continuous laboratory research, production and field experience.

Supreme Moves Offices

Supreme Publications, formerly of 328 So. Jefferson St., Chicago, has moved to larger quarters at 9 So. Kedzie Ave., where offices will occupy a section of the second floor while the warehouse and shipping rooms will be on the ground floor.

Ken Hathaway With Ward Leonard Electric

Ward Leonard Electric Company announces the appointment of Ken Hathaway as manager of its Radio Distributor Division. Ken will establish headquarters at 53 West Jackson Blvd., Chicago, Ill., where he will be centrally located.

Ken Hathaway has long been associated with the radio industry and joins the Ward Leonard Company after 2½ years of service with the government in radio and radar work. As managing director of the Radio Parts National Trade show, Ken became widely known among members of the radio trade.

George A. Hughes Dies

George A. Hughes, 71, founder and chairman of the Edison General Electric Appliance Company, died September 9, at Chicago. He was known in the industry as "the father of the electric range."

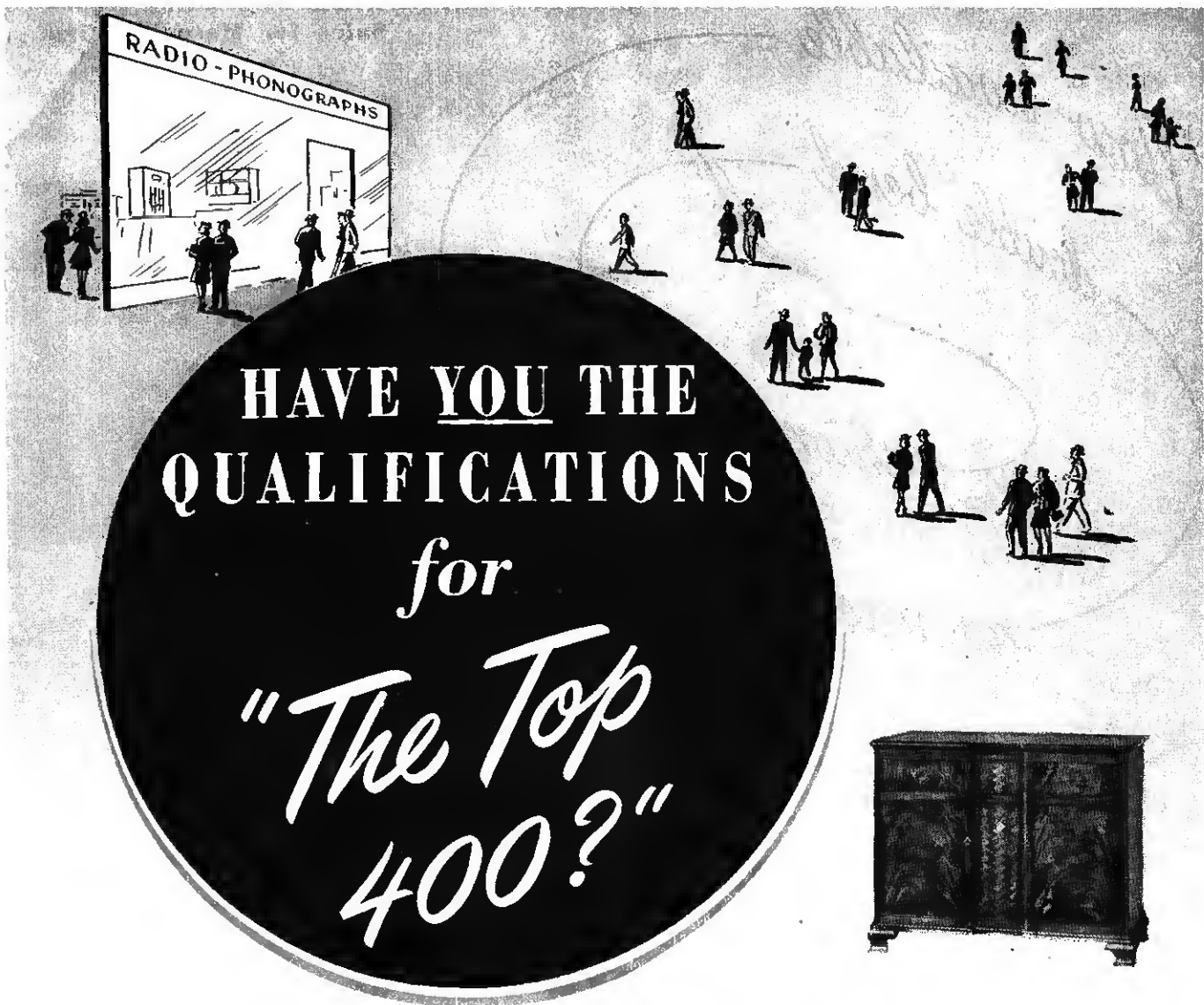

HAVE YOU THE
 QUALIFICATIONS
 for
 "The Top
 400?"

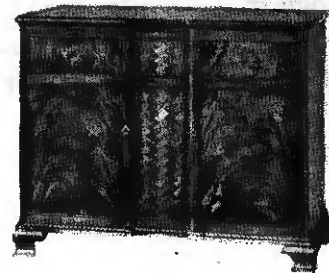

A Valuable Franchise Exclusively for Quality Dealers

ARE you one of America's "top 400" quality music furniture, radio or department stores? Do you have the clientele, finances, experience and facilities for demonstrating and selling the finest in radio-phonographs? If so, you may be able to qualify for the Freed-Eisemann Franchise, which will be offered on a protected direct-to-dealer basis.

The industry knows Freed-Eisemann as one of the foremost *quality* radio manufacturers before the war—and as the *only* manufacturer to equip *all* models with FM. The new Freed-Eisemann radio-phonographs will again be equipped 100% with FM—and

will embody all the developments and refinements achieved by Freed-Eisemann wartime research and production experience.

Standard radio, international shortwave, and reproduction of recorded music will be finer than ever. Cabinets will be superbly styled modern and period pieces—beautiful and authentic.

In our opinion, there are but 400 dealers, "the top 400," who can qualify for the Freed-Eisemann Franchise. If you are one of them, your inquiry is invited. Freed Radio Corporation, 200 Hudson Street, New York 13, N. Y.

Freed-Eisemann
 ONE OF THE WORLD'S GREAT RADIO-PHONOGRAPHS

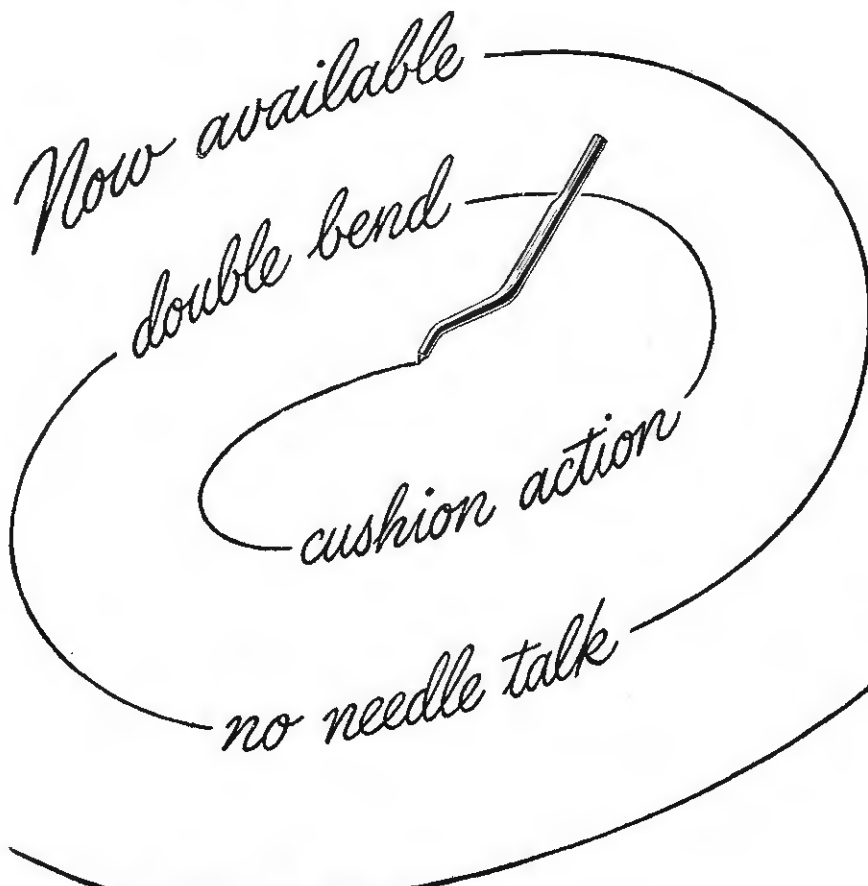

THE NEW REGENT SAPPHIRE NEEDLE

THIS extraordinary sapphire-tipped needle is setting the pace in its field. One of the finest two dollar needles made, it outstrips competition in any demonstration—and its price affords you the kind of profit margin you like. Your customers will marvel at the scratch-free reproduction of music in all ranges and be impressed by the guarantee that goes with each needle—5000 perfect plays! The new Regent Needle is individually packaged and is available attractively arranged by the dozen on a colorful display card. Order this fast-moving item today!*

**We are advertising the new Regent Needle in national magazines and by radio in the most intensive campaign in our history. Climb on the bandwagon!*

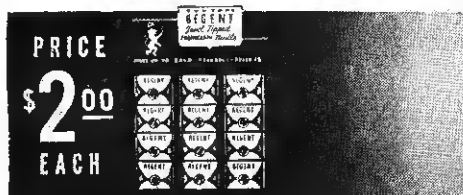

Duotone

The Duotone Co., 799 Broadway, New York 3, N. Y.
Makers of the Five Dollar "Star" Sapphire Needle

Ward R. Schafer Heads Sales for Hotpoint Firm

Ward R. Schafer has been appointed general sales manager, Edison General Electric Appliance Co., according to R. W. Turnbull, president. New regional



Appliance Merchandiser.

sales manager of the company's western region at San Francisco, Mr. Schafer has been a sales and engineering executive in Hotpoint's organization for almost 20 years.

He joined the company in 1924 as an engineer in commercial cooking sales. Later he was manager of product service for several years, and at the time war production halted sales, he was manager of the range sales division. Mr. Schafer was given a leave of absence in 1942 to join George A. Fuller Company as superintendent of construction on a \$30,000,000 butadiene plant at Houston, Texas. He rejoined Hotpoint last April.

Walter Furst Appointed

Walter A. Furst has been appointed district representative in the Pittsburgh area for the Storage Battery division of Philco Corp., according to M. W. Heinritz, vice-president in charge of the division.

Executives Promoted by International Detrola

Directors of International Detrola Corp., Detroit, have advanced several executives to higher positions, C. Russell Feldmann, president, has announced.

R. J. Nixon, Detroit, who had been assistant treasurer, was elected treasurer in succession to John Hancock, Elkhart, Indiana, who becomes general manager of the company's machinery plants in Elkhart and Indianapolis, Indiana.

Other promotions included:

R. L. Dillon, Elkhart, assistant secretary and assistant treasurer from assistant secretary and controller.

John H. Sennott, Detroit, controller of Detrola radio division.

R. P. Schmelzer, Detroit, assistant treasurer.

The corporation recently moved its executive offices from Elkhart to its Detroit radio and electronics plant at 1501 Beard St.

CALIBRATED

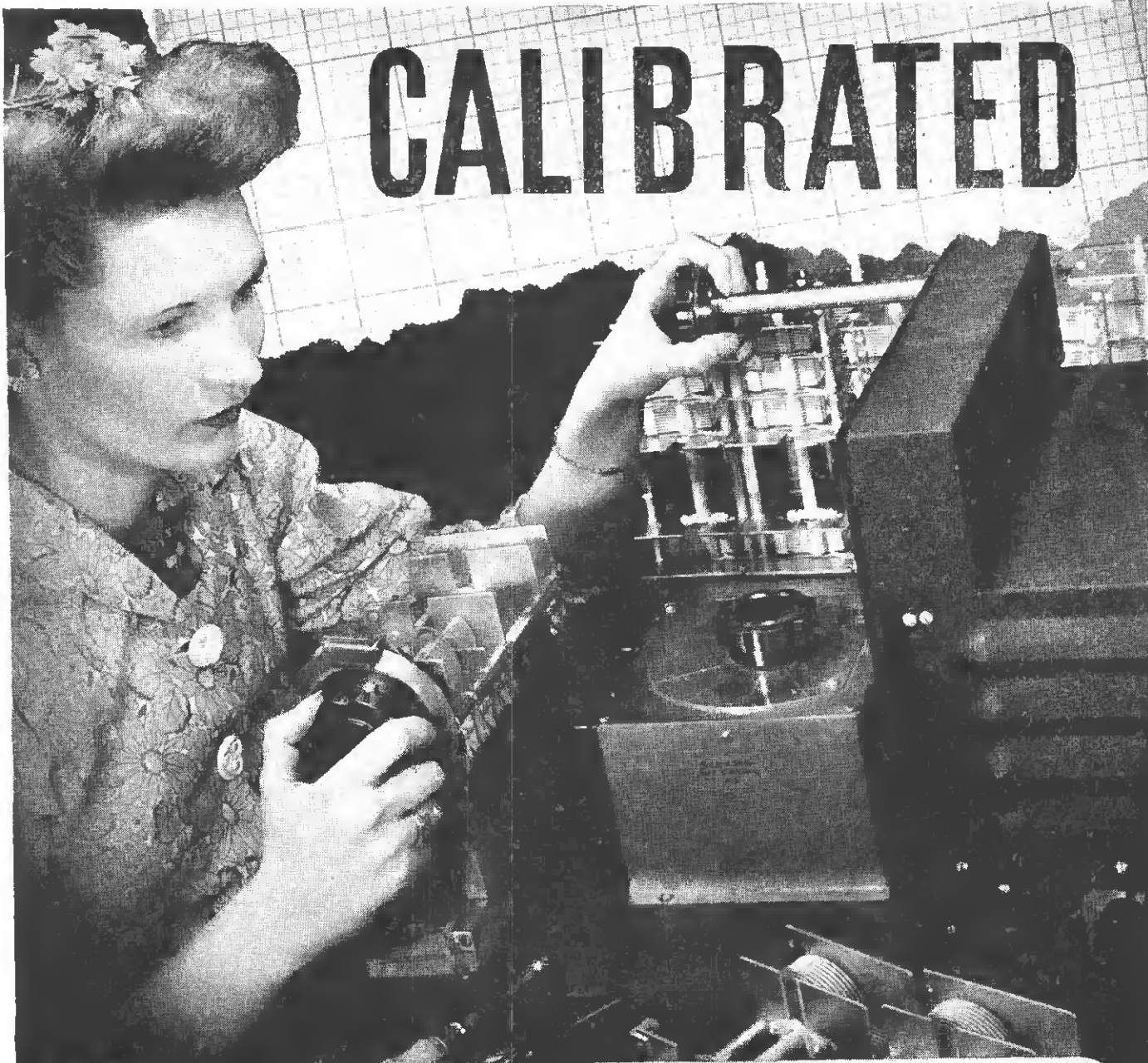

Through the development of our own highly specialized calibrating equipment Hammarlund engineers have made possible mass production of variable capacitors with accuracies comparable to laboratory standards.

HAMMARLUND



THE HAMMARLUND MFG. CO., INC., 460 W. 34TH ST., N. Y. C.
MANUFACTURERS OF PRECISION COMMUNICATIONS EQUIPMENT



Model 645 A.C.-D.C. Electronic Multimeter

(Vacuum Tube Voltmeter)

Both A.C. and D.C. volt ranges are electronic. This provides the maximum of sensitivity and overload protection for all A.C. ranges as well as D.C. and ohms ranges.

Measures resistance up to one thousand megohms and as low as 2/10 ohm.

Constant input resistance 12 megohms on all D.C. volts ranges.

Input resistance 4.4 megohms on all A.C. ranges. Flat frequency response between 50 cycles and 10,000 cycles.

Meter cannot be damaged by accidental overload on any electronic range. Electronic overload protection on all A.C. and

D.C. volts, and ohms ranges.

Variations in line voltage do not affect accuracy within the range of 100 to 125 volts. The instrument is equipped with ballast control tube and self-compensating circuits.

Meter Ranges—

A.C. Volts: 0-1/4/10/40/100/400/1000

D.C. Volts: 0-4/10/40/100/400/1000

Ohms: 0-1000/10,000/100,000/1 meg/
10 meg/100 meg/1000 meg

M.A.: 0-1/4/10/40/100/400/1000

Decibels: Minus 30 to minus 5/minus
10 to plus 15/10 to 35/30 to 35

Either positive or negative D.C. voltmeter indications instantly by means of reversal switch. Signal tracing type test lead with isolation resistor in probe. Model 645 is an ultra-modern high sensitivity instrument, with all of the famous Jackson features, including exceptional accuracy and simplicity of use.

MODEL 645

Net Price

\$56.50

Available now on rated orders . . . after war a new regular in the Jackson line . . . a line that shall always live up to a long reputation for INTEGRITY OF DESIGN.

BUY WAR BONDS AND STAMPS TODAY

JACKSON
Fine Electrical Testing Instruments

JACKSON ELECTRICAL INSTRUMENT COMPANY, DAYTON, OHIO

Congrats All Around!

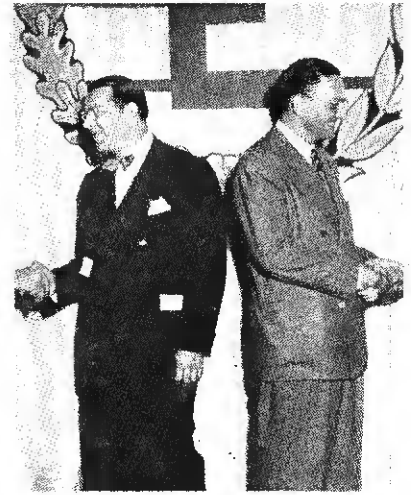

At Ward Products Corp. celebration of Army-Navy "E" Award in Cleveland, H. R. Wiesenberg, sales vice-president and R. N. Wiesenberg, president, receive congratulations of military visitors and factory personnel.

Westinghouse Views Expanding Farm Market

Because of the expanding market for electrical appliances and farm equipment, the Westinghouse Electric and Manufacturing Co. has organized a department to develop its participation in that field, according to T. J. Newcomb, sales manager of the company's electric appliance division.

At the same time, Mr. Newcomb reported the appointment of Alvan D. Peabody, who has had 34 years' experience in electrical merchandising, as head of the new department, called Rural Market Development.

"The American farmer realizes the true advantages of electric power to the operation of his enterprise and how this power can eliminate time consuming farm chores and help him produce his goods at a lower cost," Mr. Newcomb said.

"The farm market is one of the great postwar fields for the marketing of electrical appliances. The more than two and a half million farms now using electricity are building up a tremendous demand for appliances which they can't get now but will get when they are available," he continued.

Sees Vacuum Cleaner Industry on Its Toes

Following the recent meeting of the Vacuum Cleaner Manufacturers Association in Cleveland, R. J. Simmons, president of the association, stated: "Once the demands of war requirements are fully met, I am sure the same ingenuity evidenced by the vacuum cleaner manufacturers in their quick and early conversion to an all-out war effort will again be demonstrated in their reconversion and resumption of the manufacture of vacuum cleaning equipment so badly needed."

He said: "We see great opportunities to reach new peaks in production and employment for the vacuum cleaner industry as soon as government regulations permit."

IT'S THE **BIGGEST**
RADIO ADVERTISING CAMPAIGN
 RUNNING **ANYWHERE!**



RIGHT NOW — when your customers are so eager to hear more about post-war FM radio—General Electric, pioneer in this new kind of radio, is telling them in the biggest advertising campaign now being sponsored by any radio manufacturer.

G-E advertisements—like the colorful one shown above—are reaching 38,000,000 readers in 18 national

magazines every month. Millions listen regularly to the big coast-to-coast news program — General Electric's "The World Today." And the new G-E booklet, "Your Coming Radio as Forecast by General Electric" — an exclusive preview of tomorrow's radio — is being widely distributed.

This is a bang-up, build-up job — far more advertising than any other

home-radio manufacturer—in fact, as much as the next three competitors combined!

Remember, you will reap the profits from this big preselling campaign. When the war is over, G.E. will give you *THE* FM home radio to sell and a responsive market in which to sell it. Yes, G.E. tells them **NOW** so you can **SELL** them later!

GENERAL ELECTRIC IS BUILDING MORE MILITARY RADIO EQUIPMENT THAN ANY OTHER HOME-RADIO MANUFACTURER

GENERAL  ELECTRIC

175-C19

Crystal and Dynamic
MICROPHONES

**PHONOGRAPH PICKUP ARMS
 CARTRIDGES AND RECORDING
 HEADS**

**Known for efficiency, quality
 and durability. . . . Available
 with proper priority ratings.**



Manufacturing radio cable connectors, antennas, and special sound detection devices for wartime equipment.

THE Astatic CORPORATION
 CONNEAUT, OHIO
IN CANADA: CANADIAN ASTATIC LTD., TORONTO, ONTARIO

**Independent Wholesaler
 Performs Real Service**

Editor, Radio & Television Retailing:

In response to your general letter, asking for reasons why the independent wholesaler is necessary to the manufacturer and the retailer from an economic and service standpoint, we are pleased to submit the following:

Please note that we use the term, "wholesaler," rather than "jobber" because the two terms represent two totally different operations. A "jobber" may be merely what the name implies—a go-between between manufacturer and retailer, merely selling job lots of merchandise—whereas the "wholesaler" renders a service to the manufacturer and the retailer by carrying stock, providing fast and efficient service, sales help and other functions not ordinarily rendered by the type of operator whom the WPB have cataloged as "jobber."

One of the principal reasons why the independent wholesaler is necessary to the orderly distribution of merchandise is the fact that he covers the entire territory he serves—not merely the more populous centers. He thereby gives the manufacturer better blanket distribution than is possible through organizations set up merely to serve the populous centers.

The well established wholesaler, serving a limited geographical area, must, for the sake of his very existence, render complete service to his retailers, thereby giving the manufacturer more complete and more satisfactory representation than is possible by other methods of distribution.

The third reason is the fact that the well conducted wholesale institution, co-operating with aggressive retailers, places merchandise in the hands of the consumer on a lower distribution cost basis than any other method of distribution—no exceptions.

CHARLES L. WHEELER
 President, General Manager,
 The Sale Lake Hardware Co.,
 Salt Lake City, Utah

Editor's note: This excellent letter from Mr. Wheeler was received too late to include in our article, "The Independent Jobber's Place in the Sun," in the August issue.

Bell-Clark Appointed

Eastern Pennsylvania territory has been franchised for the distribution of Stromberg-Carlson products to the Bell-Clark Co., Allentown, Pa.

Warner Joins Wahn Co.

H. B. Vaughan, general manager of the George H. Wahn Co., Boston, Mass., distributors, announces that the firm has appointed L. J. ("Pop") Warner as sales manager. Warner has been in the radio and appliance business since 1924. For some time he operated his own wholesaling business, and has held important sales positions with well-known distributing firms in Massachusetts and Connecticut.



The things we make are **Vital** to the war...
do you want us to "slip you a few?"

We might—by a little fancy fenagling—slip you a few IRC wire wound Resistors and Controls. But our conscience would bother us like all get out. And we don't believe there is a single jobber or serviceman among you who—if he sat down and thought it out—would want us to. Every one of you has a relative or a friend or somebody out there fighting, and you wouldn't have us cheat him or them—not for a minute. We imagine you can get some kind of



I wish Jim could sneak home from the war. It's about over, anyway

wire wounds and controls from somebody at this time, but it just happens that ours are of a quality that Uncle Sam wants in a quantity that we can supply. In a way, we are stuck because we are so good, and we hope you'll be proud to be stuck

with us. With postwar business as the goal, there's bound to be a certain amount of off-side play. But we are not slipping anything over at the expense of our fighting boys who can't slip out of this war until it's over. If our products are so good that Uncle Sam has to have them, they must be the kind that YOU will want for YOUR CUSTOMERS as soon as you can get them.



**INTERNATIONAL
RESISTANCE CO.**

401 N. BROAD ST. • PHILADELPHIA 8, PA.

IRC makes more types of resistor units, in more shapes, for more applications than any other manufacturer in the world.



BIG VALUES IN TECHNICAL PERFECTION

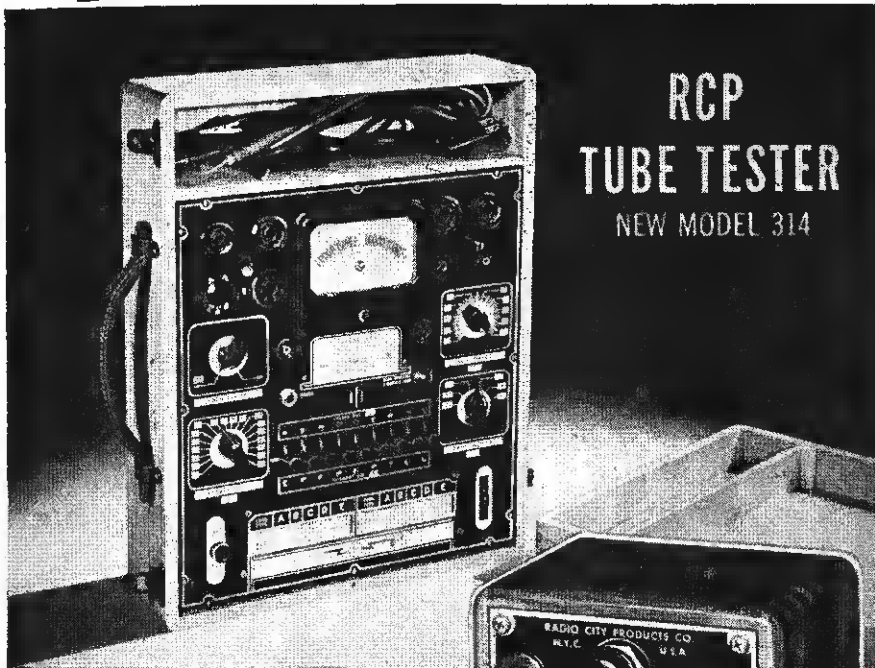

This new tube tester is simple to operate, flexible and speedier for testing Octal, Loctal, Bantam Jr., Miniature, Midget and all acorn tubes. Designed to test all present filament voltages from 1.1 to 117 volts—a range that anticipates voltages of the near future. Has sockets for all receiving tubes; no adapters required; individual connections for each element.

Lever type switching controls each tube prong, checks roaming filaments, dual cathode structures and multi-purpose tubes. Separate plate tests on diodes and rectifiers. Neon short tests detect leakage between elements while tube is hot. 4" square meter with "Poor-Good" scale. Pilot Lite indicator; double fused plug protects transformer. Durable Oak carrying case—14 1/4"x13"x6". Weight: 12 1/4 lbs. Complete ready to operate—Price: 48.50—60 cycle 110V; \$49.95—50 cycle 220V. Code: ATLAS.



POCKET MULTITESTER MODEL 420

"Pocket" size, yet rugged, with accuracy same as larger RCP models—only 6 3/4"x3 1/2"x3"—(open face) weighs only 25 ounces. Meter movement accurate within 2%. Voltage multipliers are accurate to 1%. AC and DC voltmeter up to 5,000 volts at 1,000 ohms per volt sensitivity. D.B. meter, output meter, milliammeter and ohmmeter. Total 23 ranges. Code: LIYOR. Complete, ready to operate, with batteries—\$19.95.

These are only two out of the complete line—the RCP line that built a reputation for quality and value before the war. Today it's packed with still greater technical advancements, better engineering, smarter design . . . the up-to-the-minute instrument line. Want the facts? Write today for Catalog No. 128 of standard commercial models.

RADIO CITY PRODUCTS COMPANY, INC.

127 WEST 26th STREET  NEW YORK 1, N. Y.

MANUFACTURERS OF PRECISION ELECTRONIC LIMIT BRIDGES — VACUUM TUBE VOLTMETERS
VOLT-OHM-MILLIAMMETERS — SIGNAL GENERATORS — ANALYZER UNITS — TUBE TESTERS
MULTI-TESTERS — OSCILLOSCOPES — AND SPECIAL INSTRUMENTS BUILT TO SPECIFICATIONS

Distributor Appointments

Majestic Radio & Television Corp., Chicago, has named the following distributors: J. J. Pocock, Inc., Philadelphia, pioneer refrigerator wholesaler, to represent Majestic in eastern Pennsylvania. ● Sidles Company, 502 So. 19th St., Omaha, Neb., for Nebraska and two-thirds of Iowa. ● Major Appliance Corp., 60 Arsenal St., Watertown, Mass., for greater Boston trading area and a portion of New Hampshire.

Admiral Corporation, Chicago, has made the following distributor appointments: Appliance Merchandisers, Peoria, for central Illinois. ● The Bimel Company, large commercial refrigeration and air conditioning wholesalers, for the Cincinnati territory. ● Griffith Distributing Corp., Indianapolis, organized in 1929, and prior to the war handled Admiral and Stewart-Warner lines. ● Baltimore Gas Light Co., Baltimore, Md., of which Emmett W. Cowman is manager of radio and appliance activities.

The Crosley Corp., Cincinnati, Ohio, has selected the Miami Valley Distributing Co., Dayton, Ohio, to sell Crosley products in the southwestern part of Ohio. George H. Deacon, who has had 18 years' experience in the appliance distribution business, is general manager.

Emerson Radio & Phonograph Corp., New York, announces appointments of distributors as follows: J. George Fischer & Sons Co., Saginaw, Mich. ● Toledo Appliances, Inc., Toledo, Ohio. ● Atlumor Manufacturing Co., Knoxville, Tenn. ● Schlatter Hardware Co., Ft. Wayne, Ind. ● Mayflower Sales Co., Kansas City, Mo., for the Kansas City and Wichita territories. ● Emerson's "PDQ" plan is being introduced to dealers through the company's jobbers, according to Charles Robbins, Emerson vice-president in charge of sales.

Stromberg-Carlson, New York, through Clifford J. Hunt, manager of the radio sales division, has made known the appointment of the 38-year-old Spokane Paper & Stationery Co., Spokane, Wash., for the area embracing the eastern portion of Washington, the so-called Panhandle region of Idaho and western Montana. ● Roden Electrical Supply Co., Knoxville, Tenn., will sell Stromberg products in eastern Tennessee and in portions of Virginia and Kentucky.

Landers, Frary & Clark, New Britain, Conn., has named the Rodefelf Co., Indianapolis, Ind., with branches in Richmond, Greenburg and Connersville, Ind., as exclusive distributors for "Universal" major appliances. The Rodefelf firm will handle minor appliances and household specialties on a non-exclusive basis.

Waters Conley Co., Rochester, Minn., names following Phonola distributors: The Roycraft Co., Minneapolis. ● Radio Specialty Co., Milwaukee. ● The Roycraft Iowa Co., Des Moines. ● Sampson Elect. Co., Chicago.

CEREMONY HOSTESS



Clerk Shirley Raff, Allied Radio Corp., greeted visitors as firm was awarded Navy "Certificate of Achievement." 62 Chicago firms in Chicago's radar-radio industries' front won similar honors.

C. E. Anderson Joins Olson Organization

C. E. Anderson has resigned as sales manager of Audio Devices, New York City, to become associated with John O. Olson, manufacturer's representative of Cleveland, Ohio.

Mr. Anderson's energy and knowledge of distribution has given a strong impetus to Audio sales. The addition of this "new blood" to Mr. Olson's enviable record over a long period of years promises a potential sales strength welcome to sources already represented, as well as to other quality manufacturers of allied merchandise.

Messrs. Olson and Anderson are considering a moderate expansion. Their territory includes West Virginia and Pennsylvania, in addition to the state of Ohio.

New Distributing Firm Opened in Brooklyn

Stan-Burn Radio and Electronic Co. has opened a parts distributing organization at 558 Coney Island Ave., Brooklyn, N. Y. according to an announcement from Ben Burns, president of the organization.

A complete new line of radio and electronic tubes, parts, equipment and accessories is being offered in the Brooklyn-New York City area through this new company. National Union brand tubes and parts are being featured.

Mr. Burns, president of the new Stan-Burn Radio and Electronic Company, is widely known in trade circles here due to his long years of association as manager of the Hornbeam Sales Co., Brooklyn.

Admiral Appoints United

Admiral Corp., Chicago, has appointed United Distributors, Inc., to distribute its products in the Boston trading area and part of Vermont, according to an announcement received from Ross D. Siragusa, president of the Admiral Corp.

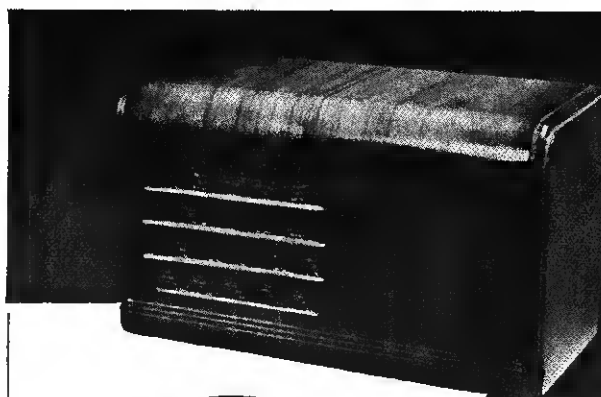

BLANKS

To accommodate various size chassis

also

"EXACT"

Replacements

Complete line to fit all standard sets
(In fine Walnut Veneers)

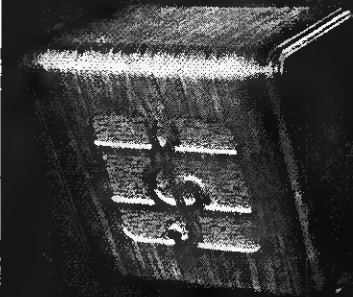

REPLACEMENT

Cabinets

for Cash sales

TODAY...

for Good-will

TOMORROW

These are the Cabinets that are piling up good profit sales for Dealers & Service-Men everywhere . . .

Not only are they answering urgent needs today . . .

they're also building New Prospects for TOMORROW

Complete Line available on L-265 Certification

All Leatherette Portables available on V-3—AA-3

Write for Catalog of Complete Line

Sold through all Leading Jobbers from Coast to Coast

SPEAKER-BAFFLES

(Wall Type)

5 Sizes . . .
Walnut & Leatherette

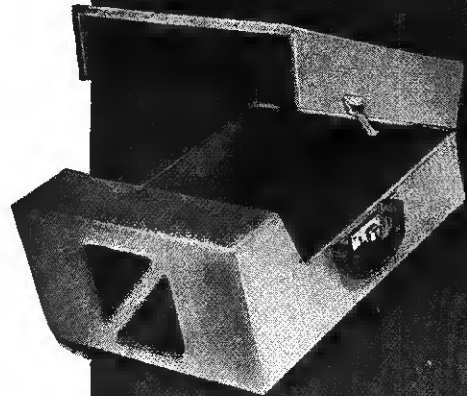

PORTABLES

For 10" or 10" & 12" Records

PHONO

(Also in Walnut Table Model)

PHONO & AMPLIFIER RECORD CHANGER

(Above in Leatherette)

*All mounting panels in blank for any required adaptation

RADIO MERCHANDISE SALES

550 WESTCHESTER AVENUE

NEW YORK 55, N. Y.



Finger-tip Information

To Answer 150 Long Distance
Phone Calls a Day

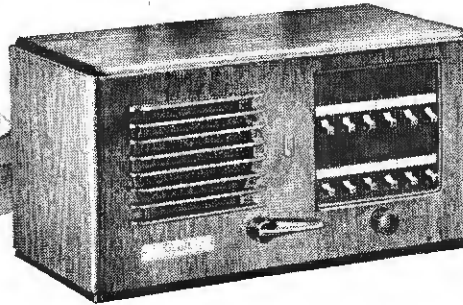

Teletalk Amplified Intercommunication enables the Independent Engineering Company of O'Fallon, Illinois, to quickly gather the information on war production required by 150 long distance telephone calls each day.

"Before installing Teletalk, time was lost in securing the required information relative to the shipment of parts or shipping time on equipment. With the Teletalk System, the desired information is at our finger tips," says Ray Christopher, vice president.

Experience of this war-busy firm, located in a small Illinois town, is typical of the time savings afforded by Teletalk in hundreds of plants and offices everywhere.

There are dozens of spots for Teletalk Systems located right in your community. They almost sell themselves these days when you show the way in which they multiply the capacity of every key worker, can pay for themselves in a few months' time by the saving of time and energy.

Make Teletalk a profitable source of new revenue. Teletalk units are available to fit the needs of both large and small businesses. They are easy to install . . . operate from the electric light circuit. It will operate for years on a minimum of maintenance.

If you are not now handling Teletalk in your community, get in touch with us at once. Let us show you the profit-building possibilities it holds for you. Write us today.



Licensed under U. S. Patents of Western Electric Company, Incorporated, and American Telephone and Telegraph Company

BUY EXTRA WAR BONDS

WEBSTER ELECTRIC CO., Racine, Wis., U. S. A.
Est. 1909. • Export Dept.: 13 East 40th St., New York (16), N. Y. • Cable Address: "ARLAB" N. Y. C.

WEBSTER ELECTRIC

Walker-Jamieson Sponsors Radio Program Series

Walker-Jamieson, Inc., distributors, 311 So. Western Ave., Chicago, are sponsoring a series of programs entitled "Any Bonds Tonight?" over WCFL every Tuesday evening at 8.45.

Not only does the program stimulate the sale of bonds, but it brings to the attention of the audience the outstanding contributions of the radioman to the maintenance of radio on the home front, and stresses the jobs radio technicians are doing in our armed forces and in our war plants.

On October 3, Walker-Jamieson's president, Ralph Walker, told how his firm is aiding the war effort by trying at all times to live up to its slogan—"Fast emergency service."

Florida Jobbers Busy

The Florida Radio & Appliance Corp., Miami, headed by J. V. D'Albora, of Cocoa, announces it will open branches in Tampa and Jacksonville. Pending moving into a new warehouse, the firm is receiving mail at P. O. Box 1088, Miami.

California Jobber Named

Crosley Corp. has announced the appointment of the Heating & Air Conditioning Supply Co., 263 Sierra St., Reno, Nev., to distribute its products in the northeastern part of California and most of Nevada.

El-Menco

MOLDED
MICA
CAPACITORS

IMMEDIATE DELIVERY-

ALL SIGNAL CORP ORDERS BEARING INSPECTION AT SOURCE; INSPECTED ON PREMISES & SHIPPED IMMEDIATELY

All R.M.A. or A.S.A. color coded

A complete stock is ready for immediate shipment of quantities, ranging from 500 to 5,000 of each capacity in regular MICA CAPACITORS in 5%, 10% and 20% tolerance and silvered MICA CAPACITORS in 2%, 5% and 10% tolerances.

Write for price sheets and complete information

Territory
open for
JOBBERS

SEND FOR OUR
SPECIAL INITIAL
ORDER OFFER

ALBERT ROTHENSTEIN

National Distributor

135 LIBERTY ST. New York 6, N.Y.

New Hamilton Division Headed by Jack Crossin

Percy L. Schoenen, vice-president of Hamilton Radio Corp., New York, has announced the organization of "Olympic Radio and Television." This is to be a separate operating division in which will be concentrated all of the marketing, advertising and sales promotional activities relating to the corporation's "Olympic"



Jack F. Crossin

line of domestic household radio receivers and radio-phonograph combinations. This move involves no change in ownership or management.

The primary purpose of the new division is to identify the Olympic trademark with the products of the company's marketing and manufacturing division.

Heading the "Olympic" division is Jack F. Crossin, until recently with Crosley and previously, for many years, eastern regional sales manager for Nash-Kelvinator.

Plans for nationwide distribution, now being completed, include a comprehensive program of national, local cooperative, trade paper, billboard and spot radio advertising.

Emerson Officials Honored By Treasury Department

Notice has been received from the United States Treasury Department that a special citation is being issued to Benjamin Abrams, president; Max Abrams, secretary-treasurer; and Jack Geartner, advertising director, officials of the Emerson Radio and Phonograph Corp., New York City, for meritorious service rendered in the Fifth War Loan Drive.

The Emerson Radio employees purchased war bonds in this drive in excess of \$950,000.

Direct Astatic Sales

Ray T. Schottenberg, William J. Doyle and Allen J. Stark will head sales activities for the Astatic Corp., Conneaut and Youngstown, Ohio, during the ensuing year, according to an announcement made by Floyd H. Woodworth, head of the corporation.

The APPLIANCE TESTER *that is held in* HIGHEST ESTEEM

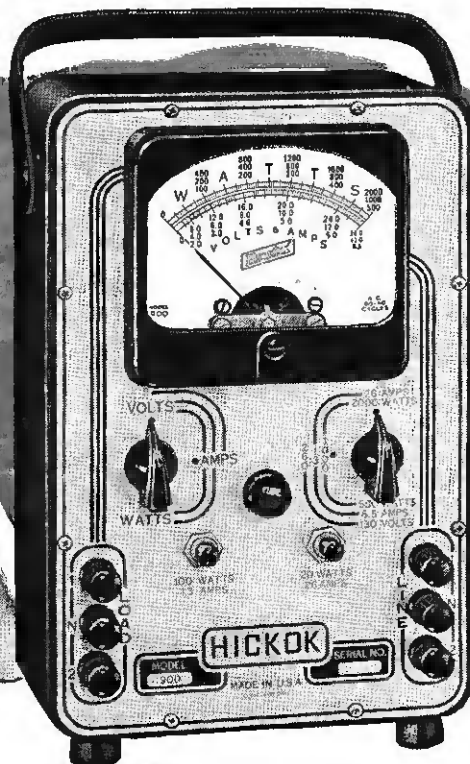

MODEL 900

HICKOK VOLT-AMP-WATTMETER

Here is an electrical Appliance Tester and Circuit Analyzer that incorporates the latest up-to-the-minute improvements. It measures actual load values of volts, amperes and watts. It is only 9½ inches high and weighs only 8½ lbs.

This improved 1944 MODEL 900 is designed for all A. C. appliance testing. It even locates trouble while the appliances are in actual operation. Tests anything from clocks and bell transformers to electric ranges operating on the 220 volt, three wire Edison system. Its No. 9A and 9B leads have standard three wire range connectors for the electric range work.

Write for special bulletin on HICKOK Model 900—the Appliance Tester and Circuit Analyzer that knows no peer.

THE HICKOK ELECTRICAL INSTRUMENT COMPANY
10523 DUPONT AVENUE • CLEVELAND, OHIO



**No Thumbing
For
TOM THUMB!**

The little man of marvelous powers doesn't need a lift — on line of march, production line or dealer showroom. Unlike Jack Horner, he has no thumbs to dip into luscious pies—no thumbs to twiddle away precious minutes.

Right now, Tom's doing a big job for the armed forces—the same big job that he always does for the jobber and dealer. They *never* have to give him a lift. Make your plans **NOW** to get on the **TOM THUMB** bandwagon.

Automatic

RADIO MANUFACTURING CO., INC.
122 Brookline Avenue, Boston, Mass.



*A new
member
of the
Family*

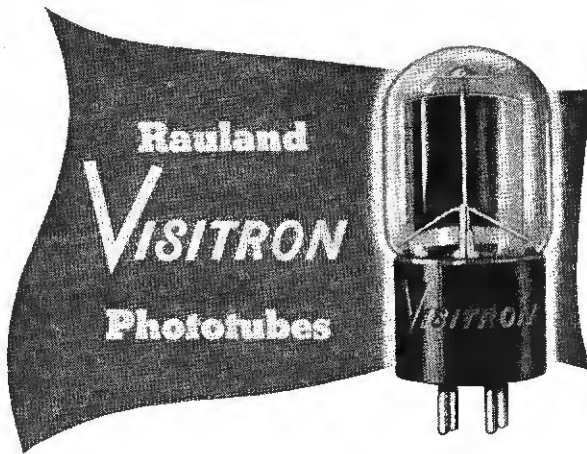

now identified with this well-known group:

- ★ Rauland **AMPLICALL** Intercommunicating and Sound Systems
- ★ Rauland Microphones
- ★ Rauland Cathode Ray Tubes

RAULAND VISITRON TUBES ARE NOW IN PRODUCTION AND AVAILABLE

THE RAULAND CORPORATION • CHICAGO 41, ILLINOIS
Electroneering is our business

**BACK THE
ATTACK**



**BUY MORE
WAR BONDS**

RADIO • RADAR • SOUND • COMMUNICATIONS • TELEVISION

Admiral Designer



Lee H. D. Baker, vice-president in charge of appliance division, Admiral Corp., announces appointment of Evans T. Morton, above, as design engineer, refrigerator division.

GE Makes Many Changes In Appliance Posts

Major changes in the General Electric Company's home appliance and construction material sales organization have been announced by H. L. Andrews, vice-president of the company.

C. R. Pritchard has been appointed to the newly created position of general sales manager of the GE appliance and merchandise department, and will be responsible for all sales and sales policies of appliances and construction materials, responsible to the vice-president.

Other appointments placed A. M. Sweeney in the position of manager of sales and of all major appliances, and C. W. Theleen in the post of manager of sales of all traffic appliances and vacuum cleaners. Both will be responsible to Pritchard, as will J. H. Crawford, who continues as manager of sales of GE construction materials. A. C. Sanger, appliance sales manager for the past year, has resigned.

A. I. Scaife has been appointed merchandising manager for the entire appliance and merchandise department, and will also be responsible to Pritchard. L. H. Miller immediately becomes manager of the household refrigerator division, and C. J. Enderle manager of the company's electric sink and cabinet division.

RMA Holds Important Meetings in New York

With R. C. Cosgrove, president, presiding, many postwar industry reconversion problems were discussed and action taken on many projects, including an RMA trade show next year, at the industry fall meetings of the Radio Manufacturers Assn., in New York.

Hurley Vice-President

Roy T. Hurley has been elected vice-president of the Bendix Aviation Corp.

SEE US!

We'll be at the Show in Chicago
with a new profit line for you . . .

ECA

... the radio man's radio

The kind of set a radio man will appreciate. The kind of set you can sincerely recommend to your friends. See us in Chicago for complete details of our postwar program:

- ◆ a strong sales policy
- ◆ complete price protection
- ◆ exclusive territorial rights
- ◆ powerful national advertising
- ◆ thousands of ready-made customers

With their **UNCENSORED** Commentaries on the news, these two nationally known radio news commentators are building up customer acceptance for the ECA radio . . .

Johannes Steel

Every Monday, Wednesday, and
Friday at 7:30 P.M. WMCA—New York



William S. Gailmer

Monday through Friday at
9:00 P.M. WHN—New York

ECA

ELECTRONIC CORP. OF AMERICA
45 WEST 18th STREET • NEW YORK 11, N. Y. WATKINS 9-1870





Still your best bet for replacements

***Old Man Centralab**

"Old Man" is right . . . for he is a real "old timer". There is no substitute for experience, and the "Old Man" now, as in the past twenty-two years, is still your best bet.

Centralab
VOLUME CONTROLS



Centralab

Division of GLOBE-UNION INC., Milwaukee

ALLIANCE "Even-Speed" Phono-motors

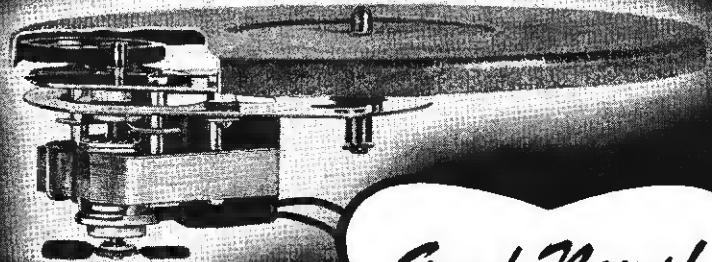

Good News!

ALLIANCE RESUMES PRODUCTION on One Standard Model

● We are now able to return to production of one standard variation of Alliance Model 80 Phono-motor, according to the following definite specifications and on the production plan explained below.

STANDARD SPECIFICATION No. 811—Turntable No. Y-278-S2; 110 Volt, 60 cycle, 9" Model 80

Production must be on the following practical basis under present conditions where there are no large volume priority orders—namely, by accumulating a sufficient quantity of small orders with necessary priority and making periodical single production runs at such time as the quantity of accumulated orders is enough to make this practical. Priority orders (currently only orders of AA-3 or higher, with GOVERNMENT CONTRACT NUMBER and MILITARY END USE, or where certified to be used in Sound Systems, Intercommunicating or Paging Systems, as exempted from order M-9-C) must allow delivery time required to obtain a minimum practical production run; to procure material for all orders in hand, and make one production run of the one type standard unit only, for shipment on the various accumulated orders. ● Check the above against your requirements, and if you have proper priority, communicate with us.

REMEMBER ALLIANCE—Your Ally in War as in Peace!

AFTER THE WAR IS WON, WE WILL TELL YOU ABOUT SOME NEW AND STARTLING IDEAS IN PHONO-MOTORS

ALLIANCE MANUFACTURING COMPANY
ALLIANCE, OHIO

Rhoades V. Newbell



New advertising manager, Magnavox Corp. Appointment announced by Frank Friemann, executive vice-president.

Blood Says Norge Plans Big Postwar Expansion

Total postwar employment in all plants of the Norge division of Borg-Warner Corp. will exceed that of the best peacetime year by 50 per cent on the basis of present plans which call for the expenditure of "very substantial sums" for expansion of production facilities, Howard E. Blood, president, disclosed following a week-long postwar planning conference in Muskegon, Mich., with Norge officials and parent company directors.

Mr. Blood also stated that the company has mapped out a program which will cut to a very minimum potential unemployment in the reconversion period and accelerate new employment.

The expansion plans, he pointed out, were made in anticipation of keen competition in the household appliance field "despite expected strong demand." However, they were also made "in confidence that the spirit of high individual productivity which has been responsible for traditional high living standards of the United States, will be restored."

Norge is prepared to go into limited production of consumer goods even before conclusion of its present war contracts provided the appropriate government agencies cooperate in making labor and materials available as war needs decline, he stated.

Leon Adelman Sales Manager at Clarostat

Leon L. Adelman has been appointed advisory sales manager of Clarostat Mfg. Co., Inc., Brooklyn, N. Y., old established manufacturer of resistors, controls and resistance devices. In addition, Adelman will also act as metropolitan New York sales representative, serving the distributors in that area.

For over 20 years Leon Adelman has been identified with the sale of radio and electronic components through legitimate distributors. Incidentally, he is an old-time "ham." He knows the technical as well as the merchandising angles, and knows the problems of the jobber.

Stromberg Sales Head



David S. Cook named sales promotion manager of Stromberg-Carlson Co.

Baumgardner Gets Radio Post With Bendix Aviation

H. L. Baumgardner, former vice-president of the George W. Borg Corp., Chicago, has been appointed district manager for the central metropolitan district for the radio division of Bendix Aviation Corp., it was announced at Baltimore, by William P. Hilliard, general manager.

From headquarters in Chicago, Baumgardner will direct introduction in the Chicago trading area of the complete line of Bendix home radio sets which the corporation will manufacture in its Baltimore plants as soon as the military situation permits, Hilliard said.

Baumgardner's territory will embrace in addition to metropolitan Chicago and its adjacent market area, the state of Michigan, the Toledo metropolitan area and part of northern Indiana, it was stated.

The selection of distributors to serve these markets is now under way.

A co-district manager, also with headquarters in Chicago, soon will be appointed by the company.

Ralph T. Perkins



Appointed home appliance manager, central district, Westinghouse Electric & Mfg. Co., in charge of Ohio-Michigan area.



BURGESS DEALERS

HOMER G. SNOOPSHAW says:
Yes, siree! We're really campaigning for you! These ads in 30 national magazines help explain homefront battery shortages and show folks how very important batteries are to our fighting men everywhere.

HE HAS YOUR BATTERY



Vital cargoes must get through to our fighting men overseas! For emergency communication the Merchant Marine depends upon portable, battery-powered megaphones. We're short of batteries on the homefront because they power countless life-saving instruments on land and sea. Use available Burgess Batteries sparingly and always try to keep them cool and dry.



BURGESS
UNI-CEL

The War Chest Helps Here and Overseas!

BURGESS BATTERIES

IN THE NATION'S SERVICE

Write Burgess Battery Co., Dept. 1044, Freeport, Ill.

BURGESS ADS ARE APPEARING IN: American Magazine, Pathfinder, Grit, Air-Trails Pictorial, Boys' Life, Country Gentleman, Progressive Farmer, Field and Stream, Sports Afield, Outdoor Life, Prairie Farmer, The Indiana Farmer's Guide, Kansas Farmer, Missouri Ruralist, Wisconsin Agriculturist & Farmer, Wallaces' Farmer & Iowa Homestead, Popular Mechanics, Popular Science Monthly, Communications, Electrical Equipment, Electronics, Modern Industry, Factory Management and Maintenance, The Instrument Maker, Instruments, Hearing News, Radio Amateur's Handbook, QST, Radio Craft, Radio News, and 1,629 weekly newspapers. Burgess Battery Company, Freeport, Illinois.

BE SURE... *Standardize on*

STANCOR *Transformers*

Call your nearest Stancor Jobber...
or write us for his address

STANDARD TRANSFORMER CORPORATION
1500 N. HALSTED STREET • CHICAGO



DEPENDABLE MUTER PRODUCTS * DEPENDABLE MUTER PRODUCTS

DEPENDABLE **MUTER** PRODUCTS

Manufacturers of Component parts for the Radio, Electronic and Communications Industries

THE MUTER CO.
1255 South Michigan Avenue
Chicago, U. S. A.

MUTER PRODUCTS * DEPENDABLE

MUTER PRODUCTS * DEPENDABLE

Bonneville Gets Crosley Merchandise Position

The appointment of E. A. Bonneville of New York as a regional manager for The Crosley Corp., has just been announced by J. H. Rasmussen, Crosley commercial manager.

For the past 14 years Mr. Bonneville had been associated with the Times Appliance Co., New York City. During that



New Regional Manager.

time he had occupied various positions in the company, and at the time he left to join Crosley he had been vice-president in charge of the appliance dealer division.

Mr. Bonneville has had wide experience in merchandising of household electrical appliances in New York department stores, appliance syndicates and chains.

Sly Visits Chicago

Cecil L. Sly, vice-president of the Universal Microphone Co., Inglewood, Cal., will represent his company at the October Electronic Parts Conference in Chicago.

Phileo Show Back On Air

The Philco "Radio Hall of Fame," which last year brought more important stars to the nationwide radio audience than any other show, returned to the Blue Network Sunday, October 1, at 6 p.m., with a series of programs destined to bring to its listeners the brightest all-star entertainment ever assembled before.

Admiral Renews Contract

The Admiral Corp., Chicago, has announced renewal of the present "World News Today" program broadcast over Columbia every Sunday at 2.30 P.M., E.W.T.

"Erla" Gets "E" Award

For excellence in war production, Electrical Research Laboratories, Inc., Evanston, Ill., has been awarded the Army-Navy "E." Ceremonies took place October 3, at Scott Hall, Northwestern University, Evanston.

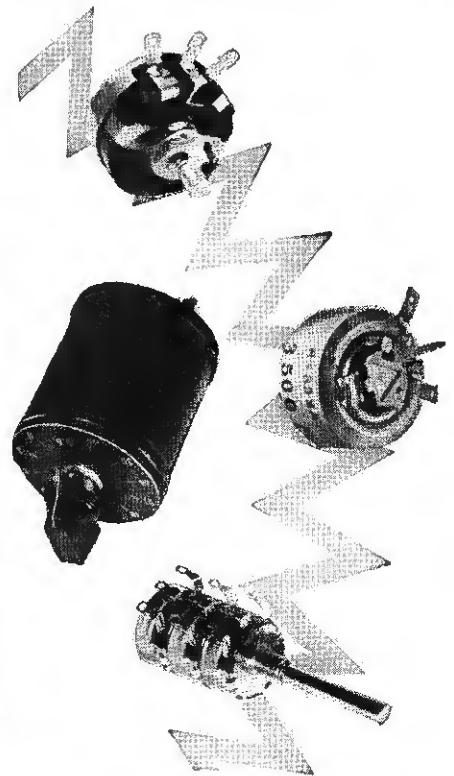

Products of "THE HOUSE OF RESISTORS"

★ Wire-wound or composition-element volume controls, T-pads, L-pads, mixers, etc.; power rheostats; constant-impedance output attenuators; power resistors; flexible resistors and glass-insulated resistors; voltage-divider resistor strips; metal-tube ballasts and resistors — these and other resistors, controls and resistance devices, comprise the exceptionally complete CLAROSTAT line — products of "The House of Resistors."

★ Consult Our Jobber



CLAROSTAT MFG. CO., Inc. • 285-7 N. 6th St., Brooklyn, N. Y.

Radio Industries Group Addressed by James Fly

James Lawrence Fly, chairman of the Federal Communications Commission, addressed a representative cross-section of the radio and allied industries in New York City at a luncheon meeting at the Hotel Astor on "Postwar Trends in Television."

The meeting was held under the auspices of the Radio and Allied Industries Committee for the Kisch Memorial Laboratories. This memorial project is designed to establish laboratories for electrical and industrial engineering at the Hebrew Institute of Technology in Haifa, Palestine. The committee has undertaken to raise \$50,000 toward the national goal of \$500,000.

Committee Members

Membership of the Radio Industries Committee includes as honorary chairman, Dr. Frank B. Jewett, president, National Academy of Sciences and vice-president, American Tel. & Tel. Co., and as chairman, Hugo Cohn, vice-president, Radio Receptor Co., Inc. Others are Benjamin Abrams, president, Emerson Radio & Phonograph Corp.; A. Blumenkrantz, president, General Instrument Corp.; Isidor Goldberg, president, Pilot Radio Corp.; Irvin Nevins, D. R. Bittan Sales Co.; Harold Shevers, president, Espey Mfg. Co., Inc.; Ludwig Arnson, president, Radio Receptor Co., Inc.; S. L. Baraf, vice-president, United Transformer Co.; Louis Cole, president, Cole Electric Products Co.; Maurice Despres, president, Dale Distributing Co., Inc.; Barney Finlay, R. H. Macy & Co.; William Fondiller, assistant vice-president, Bell Telephone Laboratories; Arthur Freed, vice-president, Freed Radio Corp.; Benjamin Gross, president, Gross Distributors, Inc.; Murray Gruhn, vice-president, Colen-Gruhn Co.; Al Jacobs, Radionic Distributors; Benjamin Kaye, vice-president, Liberty Music Shops; Jacob P. Lieberman, president, Air King Radio Co.; Lewis Newman, president, The Daven Co.; Charles Olstein, treasurer, Sanford Electronics Corp.; Perry Saftler, Manufacturer's Representative; Louis Shappe, president, Shappe-Wilkes Advertising Agency; Jules Smith, vice-president, Davega-City Radio, Inc.; David Wald, president, DeWald Radio Mfg. Co.; Max Weintraub, president, Garod Radio Corp.

Second "E" for Wilcox-Gay

Wilcox-Gay Corp., Charlotte, Mich., has been awarded its second Army-Navy "E" award for continued production performance.

J. B. Price Dies

J. B. Price, first president of "The Representatives," and widely known throughout the radio industry, died Sept. 30 at Polyclinic Hospital, New York, after a brief illness. He is survived by a widow, daughter and son. The latter is a technical sergeant in the U. S. Army.

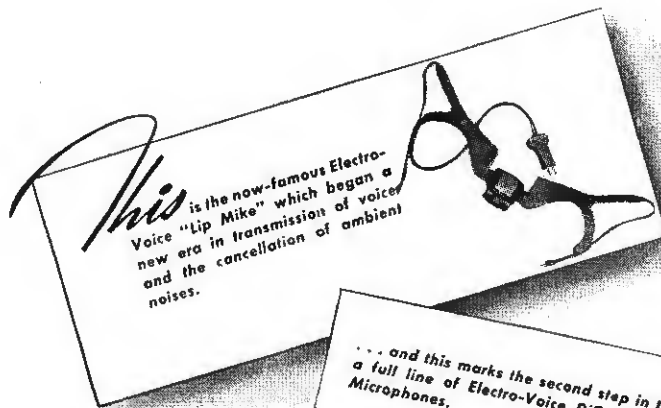

... and this marks the second step in the development of a full line of Electro-Voice Differential (noise-cancelling) Microphones.

Electro-Voice DIFFERENTIAL MICROPHONE NEW MODEL 205-S

Designed, developed and built by E-V engineers and technicians

- Provides extremely high intelligibility, even under intense surrounding noises
- A most efficient microphone for aircraft, factories, railroads, police and emergency services
- May be used in all temperatures from -40 to +185 degrees, and is interchangeable with conventional carbon microphones
- Close-talking, blast proof, waterproof and shock-resistant
- Operates satisfactorily in all positions
- Frequency response substantially flat from 100-5000 c.p.s.; high output level: -20 DB (0 DB = 1 volt/dyne/cm²); internal noise level below .001 volt.
- Press-to-talk switch opens microphone and closes relay simultaneously, if desired
- High impact phenolic case, 4" x 2-5/16"; Fiberglas wind noise filter; weighs less than 8 ounces
- Cable length, 5 ft.; panel mounting on the back; available in two models: Model 205-S, and 205-SL with switch lock.

If your present limited quantity needs can be filled by any of our Standard Model Microphones, with or without minor modifications, please contact your nearest Electro-Voice distributor.

Electro-Voice MICROPHONES

ELECTRO-VOICE CORPORATION • 1239 SOUTH BEND AVENUE • SOUTH BEND 24, INDIANA
Export Division: 13 East 40th Street, New York 16, N. Y., U. S. A. Cable: AETOH

Send for—

McGee's Fall RADIO FLYER

Sensational Vibrator Supply—replaces batteries on
Farm Radios

SPECIAL—Substitute Adapters and Tubes

LATEST—Radio Supply Merchandise

Write for your copy—TODAY

McGEE RADIO & ELECTRIC CO.

R-1044, 1225 McGEE ST.

KANSAS CITY, MO.

New Products

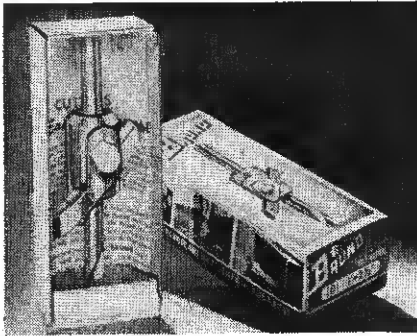

HOLE CUTTER, ADJUSTABLE, quickly cuts holes in wood, steel, aluminum, plastics and problem materials which might necessitate use of torches or other expensive equipment. One model cuts holes to any diameter from $\frac{3}{8}$ " to $1\frac{1}{4}$ " thickness. The other model covers all expansions from 1" to $2\frac{1}{2}$ " through thicknesses up to $\frac{3}{8}$ ". The tools are designed to operate in light drill presses, portable drills, or breast drills and are also available with square shanks for use in hand braces. Bruno Tools, Beverly Hills, Calif.—RTR

WALL SWITCH PLATE, LUMINITE, features tiny shielded lamp that comes on automatically when room lights are turned out, and remains off whenever room lights are burning. Makes switch easy to locate in the dark, and serves as an indication lamp at night.

Adds to utility and convenience of ordinary light switches. Associated Products Co., 74 E. Long St., Columbus, Ohio—RTR

CHASSIS CRADLE, which holds the radio chassis in an easy-to-get-at position for quick inspection or repair. Allows workers to use both hands and permits them to position working area to their convenience. Assemblies can be rotated and locked in position. Price complete \$4.95 each. Acro Tool and Die Works, 4892 N. Clark Street, Chicago 40, Ill.—RTR

ATLAS MAGNET LOUD SPEAKER, design, DR-12. All internal parts of the horn are die cast assuring close tolerances and fits. The

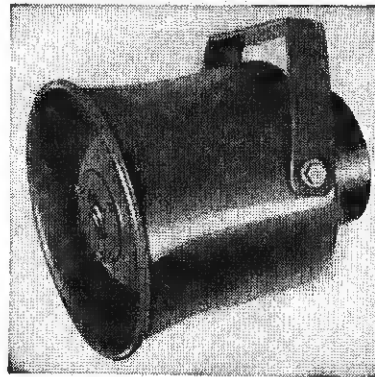

critical air column exponential expansion areas are held to $\pm .005$ assuring uniform performance and response. Directional. Light weight. Bell diameter 7", length $7\frac{1}{2}$ ". Voice coil impedance 16 ohms, power 15 watts. Atlas Sound Corp., 1443-1451 39th St., Brooklyn 18, N. Y.—RTR

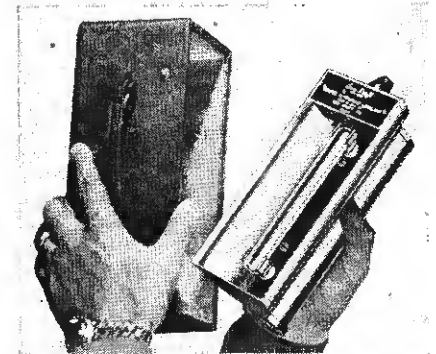

ULTRA-VIOLET RAY lamp to be manufactured after the war, will operate from car battery and be arranged to attach to dashboard or hang in any other part of car. Automobile lamp may be employed to sterilize air in car, in addition to being used for the same therapeutic purposes as ultra-violet ray lamps are used in the home. Lamp, complete with carrying case, weight three pounds. Overall dimensions $9\frac{3}{8}$ " x $4\frac{1}{8}$ " x $4\frac{1}{4}$ ". Sun-Kraft, Inc., Chicago, Ill.—RTR

RADIO CABINETS & BLANKS

Speaker Cabinets

IMMEDIATE DELIVERY

Dealers, here is your big opportunity. Stock up on a money-making assortment of Radio Blanks for quick replacements. Also Cabinets cut to fit Philco, Emerson, RCA, Fada, etc. Speaker cabinets in several sizes. Make money reconditioning old radio sets which are in great demand. Order today. Our comprehensive Catalog opens new opportunities for you.

A BIG SPECIAL!

We were fortunate in making a "big buy" and are passing the price advantage to you. A beautiful Black Imitation Leather Case with removable dial panel for easy cutting. Inside 16" long x $8\frac{1}{2}$ " deep x $8\frac{3}{4}$ " high. Order Model D-4 at dealer's price, \$3.45.

Modernistic Blanks

Beautifully grained walnut, well made. Has speaker opening. Four sizes take any chassis up to $12\frac{3}{4}$ ". Easily adaptable for reconditioning most any set.

Model No.	Long	Deep	High	Dealer's Price
A	$7\frac{1}{2}$	$4\frac{3}{8}$	$4\frac{7}{8}$	\$2.10
B	$8\frac{1}{2}$	5	$5\frac{7}{8}$	2.85
C	$10\frac{1}{2}$	$5\frac{1}{2}$	$6\frac{7}{8}$	3.00
D	$12\frac{3}{4}$	$6\frac{3}{8}$	$7\frac{7}{16}$	3.65

Center Speaker Blank

Handsome walnut finish. Fine workmanship. Most ideal for reconditioning any set adaptable to a center speaker. Inside: 11" long x $5\frac{1}{2}$ " deep x $6\frac{7}{8}$ " high. Order Model C-5 at dealer's price, \$3.00.

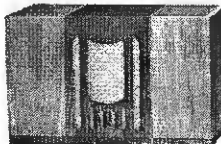
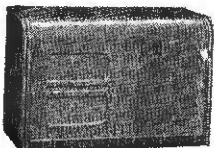

NOTE: A discount of 10% on orders for 5 or more, any model or assortment.

GUARANTEE: Shipment returnable for full refund after 5 day inspection.

SEND NO MONEY: Rush your order. We ship C, O, D. if desired. No deposit necessary.

WRITE for CATALOG: Our complete line presents unlimited opportunities for you today! Have it on hand. Write

VAUGHAN CABINET CO. 3810 N. CLARK STREET Dept. 410 Chicago 13, Ill.

ELECTRICITY

For Any Job — Anywhere

★ **ONAN ELECTRIC GENERATING PLANTS** supply reliable, economical electric service for electronics applications, and for scores of general uses.

Driven by Onan-built, 4-cycle gasoline engines, these power plants are of single unit, compact design and sturdy construction. Suitable for mobile, stationary or emergency service, intermittent or continuous.



Over 65 models available. Sizes range from 350 to 35,000 watts. A.C. types are 50 to 800 cycles, 115 to 660 volts, single or three-phase. D.C. types from 6 to 4000 volts. A.C.-D.C. combination types available. Write for engineering assistance and detailed literature.

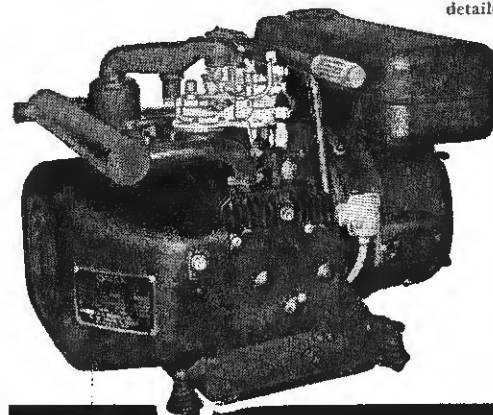

★
Plant shown is from lightweight OTC series; 1500 and 2000 watts, 115-volt, 60-cycle, A.C. and 2000 watts, 115-volt D.C.; Engine is 2-cylinder, 4-cycle, air-cooled.

D.W. ONAN & SONS 2024 Royalston Ave., Minneapolis 5, Minn.

RADIO & Television RETAILING • October, 1944

\$100,000 for Dealers in War Bond Contest

Radio retailers are offered an opportunity to win three types of prizes in the largest display contest ever held for the dealers of America. Sponsored by the Treasury Department in connection with the Sixth War Loan Drive, emphasis is placed on sales and attention appeal, artistry and originality, rather than elaborateness and cost—a natural for patriotic, live-wire dealers to compete for State, Sectional and Grand National Prizes. You compete only with radio dealers. Get in touch with your Local War Finance Chairman for details on how to win war bonds and prestige for yourself and boost your community sales. Enlist your store NOW to speed Victory!

Bendix Radio Head



Jack C. Wilson appointed Pacific district manager for home set division, Bendix Aviation Corp.

Ray Ellis Leaves WPB

Ray Ellis has resigned as head of the WPB radio and radar division, and will return to General Motors, with his headquarters in New York. Mr. Ellis has been head of the division for about two years. He is succeeded by L. J. Chatten.

Hoffman Expands Plant

Hoffman Radio Corp., Los Angeles, will add an annex to its plant No. 3 to house stockroom and engraving, incoming and final inspection, receiving, packing and shipping. It will be one story, approximately 100 x 80 feet.

Daniel J. Fairbanks Dies

Daniel J. Fairbanks, sales manager of the Cornell-Dubilier Electric Corp., South Plainfield, N. J., died suddenly September 21, in a New Bedford, Mass., hotel while visiting the New Bedford plant of the company. He was 37 years old, and was widely known throughout the radio parts industry.

Sound ideas on SOUND EQUIPMENT

*-to meet diversified
post-war requirements*

★ The principle 'an eye to the future, an ear to the ground' is particularly symbolic, in the custom-designing of special sound systems by DAVID BOGEN. Overall facilities—embodying the experience and engineering resourcefulness in coping with the vast diversity of sound problems in wartime applications—can now be concentrated en masse on peacetime industrial, professional, worship and entertainment projects. With easement of WPB restrictions for industrial sound systems indicative of further latitude in the not-too-distant future, DAVID BOGEN engineers and technicians are available for collaboration in post-war plannings.

A cordial invitation is extended to sound equipment distributors, service men and technicians to meet representatives of the DAVID BOGEN organization at the Electronic Parts and Equipment Industry Conference, October 19th, 20th and 21st, at the Hotel Stevens, Chicago.

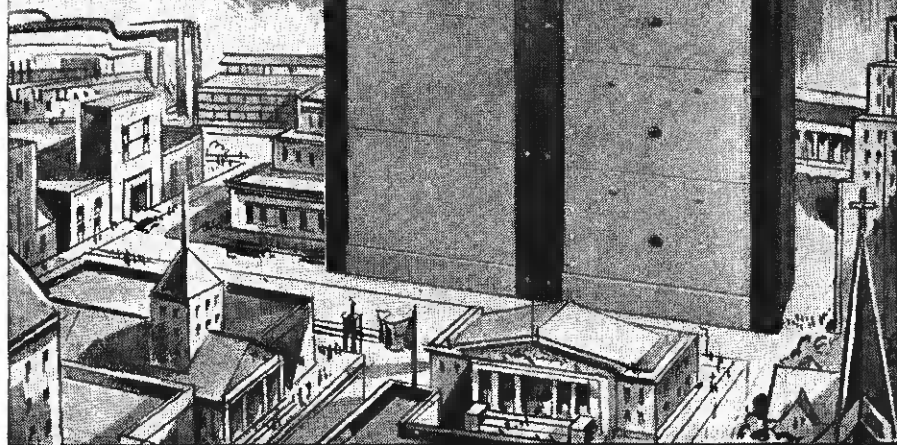
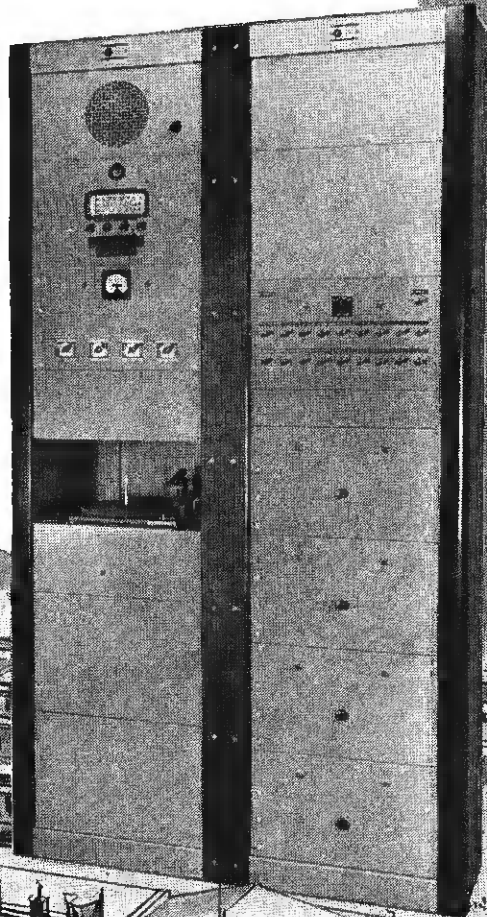

THE STANDARD OF PERFORMANCE

David Bogen CO. INC.

BOGEN SOUND SYSTEMS • AMPLIFIERS
COMMUNO-PHONES • ELECTRONIC EQUIPMENT

665 BROADWAY, NEW YORK 12, N. Y.

THE BIG NAME
IN LONG-LIFE PHONOGRAPH NEEDLES

Because

- ★ More sold than all other long-life needles combined.
- ★ Greatest Value . . . Up to 5000 Plays, \$1.00 . . . Up to 2000 Plays, 50c.
- ★ Made by world's oldest and largest manufacturers of long-life phonograph needles.

PERMO, Incorporated
6415 RAVENWOOD AVENUE
CHICAGO 26, ILLINOIS

We Don't Believe in Flag Waving!



RADIART has not publicized its outstanding contribution to the War Effort. All leading radio parts manufacturers were required to expand their efforts for the Armed Forces. Recently it was necessary to open RADIART Plant No. 3 to further increase our production. RADIART Quality has always been supreme . . . and it is being improved by exceptional engineering.

RADIART, through long range foresight, is today leading civilian Vibrator replacement production *within WPB limitations!* When peace comes RADIART Quality and Service will continue to make RADIART your best source for Replacement Vibrators.

Radiart Corporation

3571 W. 62nd St.

CLEVELAND 2, OHIO

ESICO

REG. U.S. PAT. OFF.

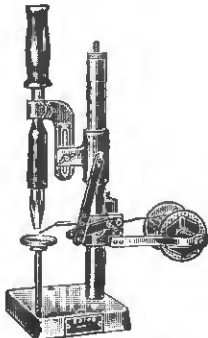

SPOT SOLDERING MACHINE
designed for treadle operation for advancement of iron and solder, leaving operator's hands free for handling of product.

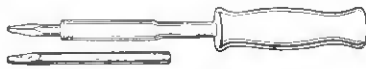

SOLDERING IRONS

are widely used in industrial plants throughout the country. They are designed to withstand the strain of continuous service required of factory tools.

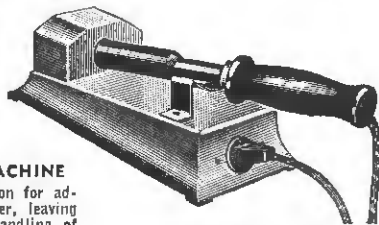

SOLDERING IRON TEMPERATURE CONTROLS
prevent overheating of soldering irons between soldering operations. Irons do not deteriorate when being used. The idle period causes oxidation and shortens life.

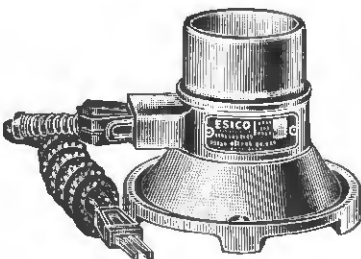

SOLDER POTS

ruggedly constructed pots of various sizes designed for continuous operation and so constructed that they are easily and quickly serviced, should elements have to be replaced.

Write for Catalog

ELECTRIC SOLDERING IRON CO., INC.

2344 WEST ELM STREET, DEEP RIVER, CONN.

Electronic Products

Testing and Recording Instruments
BATTERY ELIMINATORS

Military requirements and limitations necessarily restrict our deliveries but our best efforts are being used to apportion production fairly among all distributors.

Appreciating your understanding cooperation, we look forward to again serving adequately the requirements of industry when victory is achieved and normal conditions once more prevail.

Electro
ELECTRICAL AND RADIO EQUIPMENT

**PRODUCTS
LABORATORIES**

549 West Randolph St. Chicago 6, Ill.

Freed-Eisemann War Bond Salesladies



Left to right, Hope Correale, Florence Barashick and Genevieve Zeiss, employees of Freed-Eisemann Radio Co., receiving rewards for selling the most war bonds in company sponsored contest. Miss Barashick, winner of 1st prize, a \$100 bond, sold total of \$56,200. At right is Arthur Freed, vice president, who made the awards.

Sylvania Offers Dealer Prizes in Bond Drive

More than 500 war bond prizes will be contributed by Sylvania Electric Products Inc. to retail radio stores and service shops participating in a national display contest to promote the sale of war bonds during the sixth war loan.

The contest will be directed by the War Advertising Council at the request of the United States Treasury. War bond prizes for the best window or lobby displays devoted exclusively to the sixth war bond drive and featuring a \$100 war bond will be awarded on a state, sectional and national basis.

Each state group will have five judges including a newspaper editor, a commercial artist, an advertising agency executive, an advertising manager or a large manufacturer and a public spirited citizen. Sectional judges will include one judge from each state group and the National Committee will be made up of nine members, each a judge on a sectional committee.

Retail radio stores participating in the contest, which will begin with the announcement of the opening of the sixth war bond drive by the United States Treasury, will make photographs of their displays and send them to the Sixth War Bond Drive Display Contest Committee, care of Display World, Cincinnati 1, Ohio.

Photographs submitted to the committee should be marked on the reverse side to indicate that they are being entered in the radio stores classification. They should also indicate the name of the contestant, the name and address of the store where the display is located, and the dates the display was on view to the public.

All photographs entered in the contest will become the property of the contest committee and will be presented for use by the United States Treasury. Photographs may consist of one display or a group of displays. When group photographs are entered they should be made up of 8 x 10 prints and joined together.

Entrants will receive an acknowledgment of the photographs sent to the committee. All displays will be judged for sales appeal, attention appeal and for their artistry and originality.

Nate Hast Joins Lear, Inc. As Merchandising Head

Nate Hast, who has held executive positions over a twenty-year period with such companies as Philco and Emerson, and has been president of his own corporation, has been appointed merchandising manager of Lear, Inc.

Full information on the entry of this company (formerly Lear Avia, Inc.) into the home receiver field will be given out in the near future.

Major Slasor Appointed

Major Floyd Slasor has been named to head the Hotpoint department store sales division.

KEN-RAD

Metal Tubes

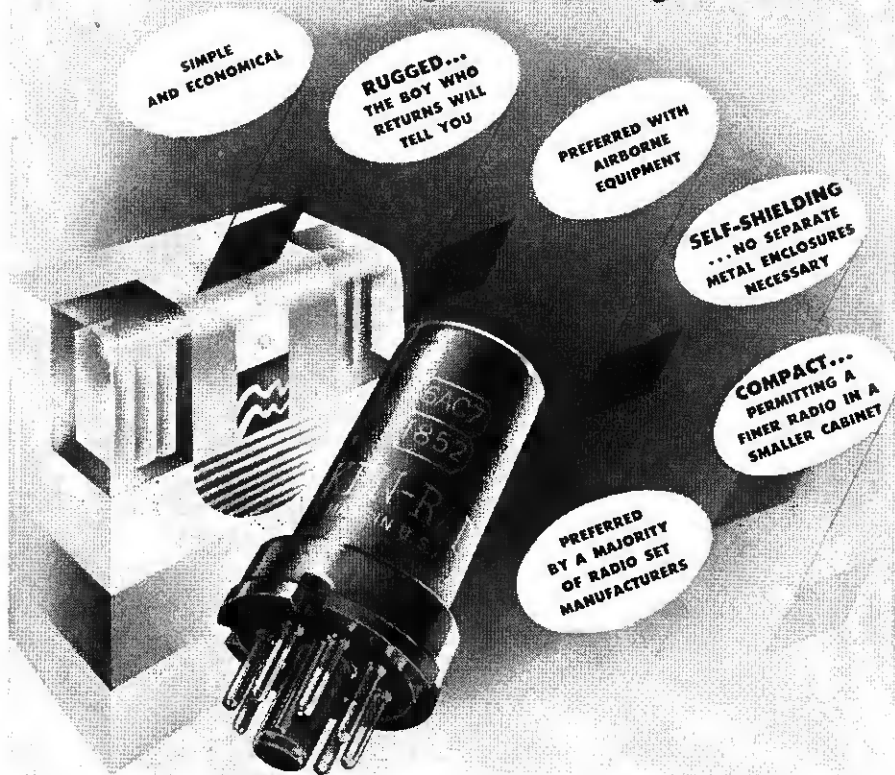

• Write for your copy of "Essential Characteristics" the most complete digest of tube information available

1934 introduced the first metal receiving tubes. In seven short years prior to Pearl Harbor over seven and one-half million new radio receivers were equipped with this finer Ken-Rad product.

- TRANSMITTING TUBES
- CATHODE RAY TUBES
- SPECIAL PURPOSE TUBES
- RECEIVING TUBES
- INCANDESCENT LAMPS
- FLUORESCENT LAMPS

KEN-RAD

EXECUTIVE OFFICES
OWENSBORO · KENTUCKY
EXPORTS 15 MOORE STREET NEW YORK



New **ATLAS Little GIANT** Model DR-12

Versatile is the word for Atlas Sound's latest creation, the DR-12 Little Giant (Bell diameter 7 in. Overall length 7½ in.) Its construction gives equally gratifying service when used for marine application, factory, police and other communications . . . a design that has proven itself more than equal to War's rigorous demands.



Write for detailed description

Complete Atlas Sound Catalog on request.

ATLAS SOUND

CORPORATION

1451 39th Street

Brooklyn, N. Y.

HATRY & YOUNG

HARTFORD 3, CONNECTICUT

PANEL METERS FOR REPAIRS

Any panel meter may be ordered on AA-3 V-3 priority. **We stock 3½" round panel meters in wide variety.**

Remember that you must be doing a repair job and that you can't just add a new meter. You cannot use the AA-3 V-3 to buy a meter you need for your work. For your own needs you can use AA-5 MRO.

It is sufficient for you to order the meter you want, mark on your order one of the above priorities and **SIGN** your order.

Your L-265 certification works the same way but must be applied to Transformers, Condensers, loud-speakers, microphones, microphone stands, tubes, resistors and volume controls. **YOU CANNOT apply AA-3 V-3 to anything classified in these kinds of repair material. YOU CAN use AA-5 MRO** when the items are for your own use in running your business and you will wear them out and not resell them.

Prompt delivery of all loud-speakers, transformers, condensers, resistors, volume-controls from a very large and varied stock.

Electronics Specialists



Consultants • Expeditors

Emerson Launches Plan Aimed to Aid Employment

With a view of expediting civilian employment of thousands of demobilized technicians of the Army Signal Corps and Naval Communications, and other radio-electronics specialists in the armed services, Emerson Radio and Phonograph Corp., New York, has begun a nationwide survey of twenty thousand dealers to determine, as nearly as possible, the future personnel needs of retailers and distributors in the radio and allied industries.

Results of the survey, showing the types and number of jobs to be filled, will be made available to governmental agencies and veterans' organizations concerned with re-employment. Letters outlining the plan and asking for cooperation have been sent to the governors of all states.

Wilcox-Gay Celebrates 25 Years in Business

September 13 marked a quarter of a century of successful manufacture for the Wilcox-Gay Corp. with C. M. ("Chet") Wilcox, as founder and president. "Chet" in somewhat of a reminiscing mood, recalls some of the many hardships and pleasures that go with organizing and heading a radio manufacturing plant for 25 consecutive years.

The company was originally located in Lansing and later moved to Charlotte, Mich. Growing from one room in 1919, to the present organization which comprises three separate divisions, i.e., "Recordio" Division, Home and Professional; Recordio Disc Division, and the Wood Working Division.

Waiting "Green Light"

For the past three years the company has been totally engaged in war production. Comprising the company's early manufacture was radio parts and receiving sets, for export as well as domestic trade.

Today, the company enjoys national distribution through outstanding distributor organizations, which along with the company, are anxiously awaiting the green light for the postwar market.

When asked to make a statement regarding the future of Wilcox-Gay, "Chet" replied: "While we are soon faced with the problems of reconverting to civilian work from all out war production, I believe that our organization can look forward to a continuation of our past record of growth and success.

Postwar Future Bright

"Our opportunities in the postwar market are tremendous. We have a new product in the Recordio which was only nicely inaugurated when war prevented its further development.

"We have a national and international sales acceptance and we have through the years built an internal organization of capable people.

"Rather than to predict the future, however, I prefer to take this opportunity to thank the people who have worked with me through the past years and who are really the ones to have the credit for the success of the corporation."

Urging "One-Price" on "Ham" Receiver Sets

Talks with persons interested in the sale of amateur receiving sets reveal that they are hoping for postwar elimination of "fictitious" and complicated list and net pricing methods which have been employed by some manufacturers in the past.

It is felt that the net price should be the selling price and that a new pricing system would work hardships on no one in the industry, but would simplify the entire selling structure in the amateur set field.

Now is the time to iron out this situation, proponents of the plan point out. After civilian production is resumed it will not be so easy to launch such a plan as it is at the present time.

The whole problem is simple to solve, it is stated. All that is necessary to do to remedy the situation is to handle pricing of amateur sets in the same manner that some receivers are priced, with the selling price advertised and the dealer's discount price not appearing in print.

RADIO & TELEVISION RETAILING welcomes opinions on this subject and will print comment received in future issues.

Haynes-Griffin

(Continued from page 46)

Records are the mainstay now, and will be tomorrow's traffic builder. Option has been allowed for the second floor. The basement will be used to display major appliances and will include a complete electric kitchen. Retailer Lohman already has his franchises set for postwar selling. He will handle Bendix washers and all General Electric major appliances.

The second floor will display more expensive radios, ranging from \$350 to \$2,000—Philharmonic, General Electric Musaphonics, RCA Victors, Stromberg-Carlson, and others in the top price lines.

After the war selling will depend a great deal on the manufacturers, so, says George Lohman. If the manufacturer cuts his discount he will lose the "class accounts." A dealer must have 40% to make any kind of money at all. That should be the minimum margin.

Since settling in his new location, his merchandiser has sales figures to show an up for the month of August, 1944, 90% over August, 1943. This is on general sales. Average record sales for this year, January through August, are 70% over the same period last year. This is "despite the fact that we have to turn down 40% of the people in the store because we don't have what they want due to merchandise shortages," claims Lohman.

"Our theme song seems to be 'No,'"
(Continued on page 116)

Templetone Plans for Increased Peacetime Sales

Templetone Radio Co., Mystic, Conn., makers of Temple radio, have announced the acquisition of a new site for its radio and electronic divisions.

The new plant, possessing an area of 90,000 square feet of space, is rapidly being converted and will be occupied by Templetone about November 1.

In announcing this expansion of the company's facilities, Oscar Dane, head of the company, stated that while the radio and electronics divisions will be moved to New London, the company will retain its Mystic plant, the latter to be devoted entirely to the manufacture of radio cabinets.

Mr. Dane declared that the new plant

has been acquired with the idea of expansion in peacetime when the company, presently engaged in making important war equipment, will produce complete lines of Temple radios, embracing FM and television sets.

Philco Promotions

Leslie J. Woods, who joined Philco in 1925, has been named manager of the industrial radio division of Philco Corp., with headquarters in Detroit where Philco will continue to maintain special facilities to serve the automobile and aircraft industries, according to John Ballantyne, president.

Martin F. Shea has been appointed assistant manager.

"THE HELP SITUATION by J. F. Rider

Agencies Established For Placing Men Trained in Wartime Radio

New York—Oct. 1, 1944: Every month brings the establishment of a more complete machine for the replacement of the millions who will be released from war activities when Victory comes to the Allies. Employees seeking help are advised to communicate with:

1. Any of the eighteen camps established by the Army as separation centers.
2. The local draft board and its re-employment committee man.
3. The local U. S. Employment Service office.
4. The Veterans' Service Center.

There are thousands of men who know nothing of radio before the war, who during their term of military service or work at war-plants have been thoroughly trained in the theory and practice of electronics.

Thousands of dollars were spent by industry and the Government in training these people. Their knowledge and skill are now available to employers who communicate with the proper Government offices.

HERE'S
VALUABLE HELP
FOR YOU

RIDER MANUALS (13 VOLUMES)

Volumes XIII to VII.....\$11.00 each volume
Volumes VI to III..... 8.25 each volume
Abridged Manuals I to V [I volume].....\$12.50
Automatic Record Changers and Recorders 6.00

OTHER RIDER BOOKS YOU NEED

The Cathode Ray Tube at Work
Accepted authority on subject.....\$3.00
Frequency Modulation
Gives principles of FM radio..... 1.50
Servicing by Signal Tracing
Basic Method of radio servicing..... 3.00
The Meter at Work
An elementary text on meters..... 1.50
The Oscillator at Work
How to use, test and repair..... 2.00
Vacuum Tube Voltmeters
Both theory and practice..... 2.00
Automatic Frequency Control Systems
—also automatic tuning systems..... 1.25
A-C Calculation Charts
Two to five times as fast as slide rule..... 7.50
Hour-A-Day-with-Rider Series—
On "Alternating Currents in Radio Receivers"—
On "Resonance & Alignment"—
On "Automatic Volume Control"—
On "D-C Voltage Distribution"..... 90c each

JOHN F. RIDER PUBLISHER, INC.

404 Fourth Avenue, New York 16, N. Y.
Export Division: Rocke-International Electric Corp.
13 E. 40th Street, New York City Cable: ARLAB

Currently, 70,000 discharged veterans are re-entering industry every month. With the coming of victory, some 8,000,000 service men and 20,000,000 war workers will seek new employment.

Hundreds of thousands of these people have been trained in radio. Here is your answer to the liquidation of that huge pile of unfinished work in your shop. Contact the various agencies that are trying to find peace-time jobs for these men you need.

But get them started right in your shop. Furnish them with the authoritative and necessary servicing information contained in Rider Manuals; a complete set for each bench.

Make available to them too, the other Rider Books that are full of helpful hints on civilian set maintenance. Do these things now—today.

PLACE YOUR ORDER TODAY

RIDER MANUALS
GIVE YOU THE HELP YOU NEED!



DUMONT

OIL-FILLED
Ceramic
SEALED
CAPACITORS

For
Dependable
Service
Work

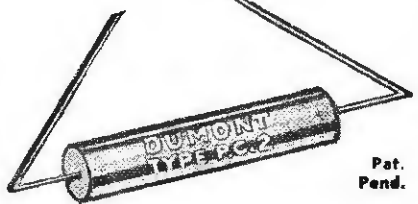

Pat.
Pend.

- For long life in repairs for those expensive high-class service jobs on amplifiers, public address, police and school systems and all good electronics equipment.

All capacitors from .0001 to .25 from 600 volts to 2000 volts.

It is
your duty
to buy
war bonds

Literature and prices
on request

**DUMONT
ELECTRIC CO.**
MFRS OF
CAPACITORS FOR EVERY REQUIREMENT
34 HUBERT STREET
NEW YORK, N. Y.

Haynes-Griffin

(Continued from page 115)

but our number of transactions are up 100% over last year."

A word about sales people. George Lohman advocates encouragement of his force in every possible way. He takes the lead in the situation and makes suggestions that guide a selling person's thinking toward more sales. Especially in the sale of records he advises—"Be gay—Be liked—Don't be a snob." The customer must be considered and common courtesy is his first requisite.

Spacious as Haynes-Griffin's store is, there is no waste space. The walls are painted a forest green and no pictures detract from the merchandise display. This cool, modern, good-looking color is the background against which *merchandise is displayed*, and record albums in self service arrangement stand out as all-important to the prospective purchaser.

Discs Classified

A careful arrangement of disc divisions is one of Haynes-Griffin's smartest sales policies. Miss Alma D. Kraushaar, record department manager, has made a complete study of record arrangement. Her classification of discs and albums makes the store's self selection operation a success. The divisions follow: Symphonies, Concertos (Violin and Piano), Tone Poems, Chamber Music, Overtures, From the Opera (Selections), Folk Music of Many Lands, Children's Records, Complete Operas, Dinner Music (Piano Selections), Popular Albums, Latin American Music, Russian Music, Readings.

Stocks Handy

In addition to stock space for records in the basement, a neat and handy set-up is arranged for stock on the same floor with record sales. Occupying the street floor, disc stock is kept directly behind the sales space, in a room on the same floor. This space is dedicated to immediate current stock. The record manager's office is also in this section and has direct buzzer contact with bookkeeping department and basement stock attendants. Radio service is also handled in the basement of the store.

Dealer Lohman is headed for year-round selling in the postwar period. Everything for the home that is electrical is his motto. Coolers and freezers in the summer; music and entertainment for the winter.

Proven!
25,000 OHMS PER VOLT
PUSH BUTTON OPERATED
SPEED TESTER
SUPREME MODEL
592

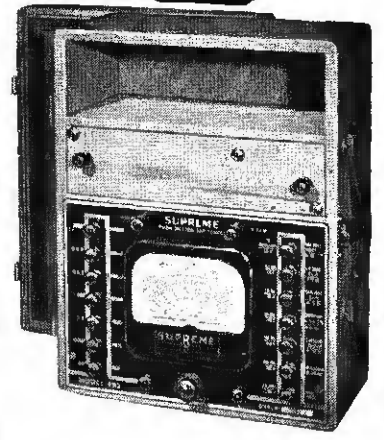

- ★ Design proven by over 5 years production
- ★ Dual D.C. Sensitivity—25,000 ohms per volt and 1000 ohms per volt.
- ★ Matched resistors of 1% accuracy
- ★ Push button operated—no roaming test leads
- ★ Open face—wide scale 4 1/4" meter, 40 microamperes sensitivity.
- ★ 1 Microampere first scale division.

SPECIFICATIONS

- D.C. MICROAMPERES: 0-70-700 microamperes
- D.C. MILLIAMMETER: 0-7-35-140-350 milliamperes
- D.C. AMMETER 0-1.4-14 amperes
- D.C. VOLTS, 25,000 OHMS PER VOLT: 0-3.5-7-35-140-350-700-1400 volts
- D.C. VOLTS, 1000 OHMS PER VOLT: 0-3.5-7-35-140-350-700-1400 volts
- A.C. VOLTS, 1000 OHMS PER VOLT: 0-7-35-140-350-700-1400 volts
- OUTPUT VOLTMETER: 0-7-35-140-350-700-1400 volts
- DECIBEL METER: 0 db to plus 46 db
- OHMMETER: 0-500-5000-50,000-500,000 OHMS 0-5-50 MEGOHMS
- POWER SUPPLY Battery Operated

With the above specifications the Supreme Model 592 Speed Tester meets today's requirements for general laboratory use, assembly line tests and inspection, radio and other electronic repair and maintenance.

SUPREME
TESTING INSTRUMENTS
SUPREME INSTRUMENTS CORP.
Greenwood, Miss., U. S. A.

Originality

that Started a New Era
in Screwdrivers



REGULAR
SIZES



STUBBY

FOR CLOSE
QUARTERS

And a New Era in
Customer-Appeal
XCELITE
Screwdrivers

The Xcelite design lifted screwdrivers out of their age-old rut! The original screwdrivers with transparent, shock-proof, fire-resistant handles of special plastic, Xcelites are skillfully balanced, with comfortable grip, plus blades of high quality steel accurately machined. Ideal for all electrical and mechanical work. Over 50 sizes and styles, round and square blades, standard and "stubby" models. Priorities required in most instances. Details and prices on request. Write Dept. M.

MORE TO COME! Many new, original Xcelite tools are in the making. You'll welcome these unique contributions to your tool merchandising program—when war restrictions are lifted.

PARK METALWARE CO., INC.
Orchard Park New York

XCELITE

Buy Another War Bond—Keep the Ones You Own

ANTENNAE AND ASSOCIATED PRODUCTS



SNYDER MFG. CO.
RADIO & AUTOMOTIVE PRODUCTS • PHILA. 40, PA.

ADIO & Television RETAILING • October, 1944

Model GI-R90 Dual-speed home recording and phonograph assembly.

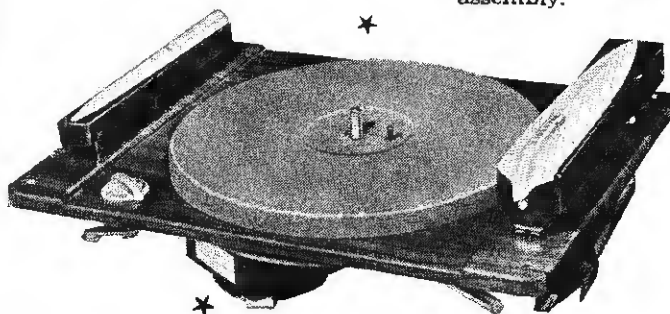

AT WAR NOW . . .

but they'll be back!

Soon, we hope, we can get back into the business of supplying you with those reliable recorders, *Smooth Power* motors, turntables and record changers, deliveries of which we have had to discontinue because of war obligations.

When that time comes, you can be sure of the same high quality, sturdiness and dependability which have always distinguished the products of General Industries. Beside this, from the varieties and types of products which we have been making for military use, we have derived some very practical ideas that will improve and expand our prewar line of equipment.

So, when you are thinking about postwar electric, mechanical or electronic devices, be sure to include General Industries in your planning. Right now, we can't offer you engineering or production facilities, but we can talk over your requirements in general terms, and get down to facts and figures later. We'll be glad to hear from you.



THE GENERAL INDUSTRIES COMPANY
DEPT. M . . . ELYRIA, OHIO

THE
GI GENERAL INDUSTRIES COMPANY



Smooth Power

CORWICO

WIRES

MADE BY
*Engineers FOR
Engineers*

concentrating upon **VICTORY**
for the duration

cornish
WIRE COMPANY, INC.
15 Park Row, New York City, New York

CORWICO

Will Make Home Radios

Following is a list of manufacturers which, RADIO and Television RETAILING has reason to believe, will produce home radio sets after Germany collapses. Besides the many familiar names of pre-Pearl Harbor recollection, there are included a number of new names of companies which have announced plans to enter the home-radio field, as verified by your editors. Those newcomers which did not make home radios in 1941-42 are indicated by an asterisk, thus*:

- Admiral Corp., 3800 W. Cortland St., Chicago 47, Ill.
- Alr-King Products Co., Inc., 1523 63rd St., Brooklyn 19, N. Y.
- Andrea Radio Corp., 43-20 34th St., Long Island City, N. Y.
- Ansley Radio Corp., 21-10 49th Ave., Long Island City, N. Y.
- Arvin—see Noblitt-Sparks Industries, Inc.
- Automatic Radio Mfg. Co., 124 Brookline Ave., Boston, Mass.
- Belmont Radio Corp., 5921 W. Dickens Ave., Chicago 39, Ill.
- *Bendix Radio, Div. of Bendix Aviation Corp., East Joppa Rd., Baltimore 4, Md.
- Browning Laboratories, Inc., 750 Main St., Winchester, Mass.
- Brunswick—see Radio & Television, Inc.
- Clarion—see Warwick Mfg. Corp.
- Colonial Radio Corp., 254 Rano St., Buffalo, N. Y.
- *Columbia Associates, 141 W. 24th Street, New York, N. Y.
- Crosley Corp., 1329 Arlington St., Cincinnati.
- Delco Radio, Div. General Motors Corp., Kokomo, Ind.
- DeWald Radio Mfg. Corp., 444 Lafayette St., New York, N. Y.
- Allen B. Dumont Labs., Inc., 2 Main Ave., Passaic, N. J.
- Eckstein Radio & Telev. Co., 914 La Salle Ave. Minneapolis, Minn.
- Electrical Research Labs., Inc., 2020 Ridge Ave., Evanston, Ill., "Sentinel"
- *Electronic Corp. of America, 45 W. 18th St., New York, N. Y.
- Emerson Radio & Phono. Corp., 111 8th Ave., New York, N. Y.
- Empire Radio Mfg. Co., 114 E. 47th St., New York 17, N. Y.
- Espey Mfg. Co., 305 E. 63rd St., New York.
- Fada Radio & Elec. Mfg. Co., 3020 Thomson Ave., Long Island City, N. Y.
- Farnsworth Telev. & Radio Corp., 3700 Pontiac St., Ft. Wayne, Ind.
- Freed Radio Corp., 200 Houston St., New York.
- Galvin Mfg. Corp., 4545 Augusta Blvd., Chicago, Ill., "Motorola"
- Garod Radio Corp., 70 Washington St., Brooklyn, N. Y.
- General Electric Co., 1287 Boston Ave., Bridgeport, Conn.
- General Television & Radio Corp., 1240 N. Homan Ave., Chicago, Ill.
- Gilfillan Bros., 1815 Venice Blvd., Los Angeles, Calif.
- Hamilton Radio Corp., 510 Sixth Ave., New York, N. Y., "Olympic"
- *Herbach & Rademan Co., 522 Market St., Philadelphia, Pa.
- *Hoffman Radio Corp., 3430 S. Hill St., Los Angeles, Calif.
- Howard Radio Co., 1735 Belmont Ave., Chicago, Ill.
- *Industrial Tool & Die Works, Inc., 2824 University Ave., S.E., Minneapolis, Minn.
- International Detrola Corp., 1501 Beard St., Detroit, Mich.
- *Keith Radio Products, Bedford, Ind.
- Kingston Radio Co., Inc., Kokomo, Ind.
- *Lear Avia, Inc., Piqua, Ohio
- The Magnavox Co., Ltd., 2131 Bueter Rd., Ft. Wayne, Ind.
- *Maguire Industries, Inc., 342 West Putnam Ave., Greenwich, Conn.

(Continued on page 119)



TEAMWORK IN TANKS DEPENDS ON

"Electronics"

Hard fighting tank crews rely on Operadio-built electronic interphone systems for split-second timing! On the production front, busy war plants are using the same communication system—Operadio FLEXIFONE—to speed production. For peacetime, Operadio is planning even better electronic products that are bound to build post-war business for you!

OPERADIO

Electronic Specialists

OPERADIO MANUFACTURING CO., ST. CHARLES, ILL.

QUICK DELIVERY!

P/M SPEAKERS
For radio extensions, call systems, etc.
4" (square) \$1.25
5" (round) 1.25

NAT'L UNION SAV-A-SHAFT
Volume controls with switch attached; uses shaft from original control.
½ megohm tapped 59c
1 megohm tapped 59c

MALLERY - AEROVOX - SPRAGUE CONDENSERS
20 mfd 150v Tubular 44c
50 mfd 150v Tubular 65c
20-20 mfd 150v Tubular 76c
30-30 mfd 150v Tubular 79c

"Get-Acquainted" Offer
Free! A pair of test leads listed at \$1.35, with your order of \$10 or more. Order today!

COPPER WIRE
Stranded, silk covered, enameled. 88 strands, very flexible. Approx. size No. 18. For AC-DC hanks, lead-ins, etc.
1000 ft. \$3.00

HOOK-UP WIRE
High grade wire, glass insulated and oil resisting lacquer. Size No. 20. 100 ft. \$1.16

Radio Warehouse
73-D MILL ST., AKRON 8, OHIO

JUST OUT

NEW FLAT RATE RADIO SERVICE SCHEDULES

for

\$2.50 and \$3.00 per hour

These contain 234 different rates in alphabetical order, 160 cross references, 372 rate quotations, 236 new time ratings, 215 reminders about other charges that might otherwise be overlooked, and 352 detailed instructions.

Also

ENLARGED TUBE SECTION

Contains 1095 substitutions, 3500 socket connection notations, 190 instructions, and 390 references. Data is with each tube.

These two new books are \$1.00 each.

ALSO AVAILABLE

Flat Rate Books without the enlarged tube section based on the following rates per hour for labor.

\$1.00	\$1.75	\$2.50	\$3.25
\$1.25	\$2.00	\$2.75	\$3.50
\$1.50	\$2.25	\$3.00	

These books are 35c each or 3 for \$1.00.

RADIO EQUIPMENT CO.

1415 W. FRANKLIN AVE.
MINNEAPOLIS 5, MINN.

Will Make Home Radios

(Continued from page 118)

- Majestic Radio & Telev. Corp., 2600 W. 55th St., Chicago, Ill.
- *Mason Radio Products Co., Kingston, N. Y.
- *John Meck Industries, Plymouth, Ind.
- *Meissner Mfg. Co., Mt. Carmel, Ill.
- Midwest Radio Corp., 909 Broadway, Cincinnati, Ohio
- Motorola—see Galvin Mfg. Corp.
- National Co., 61 Sherman St., Malden, Mass.
- Noblitt-Sparks Industries, Columbus, Ind., "Arvin"
- Olympic—see Hamilton Radio Corp.
- *Pacific Electronics, Sprague at Jefferson, Spokane 5, Wash.
- Packard Bell Co., 1115 S. Hope St., Los Angeles, Calif.
- *Packard Mfg. Co., Kentucky & Morris Ave., Indianapolis, Ind.
- Philco Corp., Ontario & C Sts., Philadelphia, Pa.
- Philharmonic Radio Corp., 216 William St., New York, N. Y.
- Philmore Mfg. Co., 113 University Pl., New York, N. Y.
- Pilot Radio Corp., 37-06 36th St., Long Island City, N. Y.
- *Precision Specialties, 210-220 N. Western Ave., Los Angeles, Cal.
- Radio & Television, Inc., 244 Madison Ave., New York, N. Y., "Brunswick"
- Radiola—see RCA Victor Div., Radio Corp. of America
- RCA Victor Div., Radio Corp. of America, Camden, N. J.
- *Regal Electronics Corp., 20 W. 20th St., New York, N. Y.
- Remler Co., Ltd., 19th at Bryant, San Francisco, Calif.
- E. H. Scott Radio Labs., Inc., 4450 Ravenswood Ave., Chicago, Ill.
- *Searle Aero Industries, Inc., Orange, Cal.
- Sentinel Radio Corp., 2020 Ridge Ave., Evanston, Ill.
- Setchell-Carlson, Inc., 2233 University Ave., St. Paul, Minn.
- *Sheridan Electronics Corp., 2850 S. Michigan Ave., Chicago, Ill.
- *Signal Electronic & Mfg. Co., 114 E. 16th St., New York, N. Y.
- Sonora Radio & Telev. Corp., 325 N. Hoyne Ave., Chicago, Ill.
- Sparks-Withington Co., 2400 E. Ganson Ave., Jackson, Mich., "Sparton"
- *Sperti, Inc., Beech & Kentucky Ave., Norwood Sta., Cincinnati, Ohio
- *Spokane Radio Co., Inc., P. O. Box 16, Spokane, Wash.
- Stewart-Warner Corp., 228 N. LaSalle St., Chicago, Ill.
- Stromberg-Carlson Co., 100 Carlson Rd., Rochester, N. Y.
- Templetone Radio Co., Mystic, Conn.
- Transitone—see Philco Corp.
- Trav-Ler Karenola Radio & Tel. Corp., 1028 W. Van Buren St., Chicago, Ill.
- Troubador—see Warwick Mfg. Corp.
- *Viewtone Co., 203 E. 18th St., New York, N. Y.
- Warwick Mfg. Corp., 4640 W. Harrison St., Chicago, Ill., "Troubador," "Warwick"
- Watterson Radio Co., P.O. Box 54, Dallas, Texas
- Wells Gardner & Co., 2701 N. Kildare Ave., Chicago, Ill.
- *Westinghouse Elec. & Mfg. Co., 200 W. Baltimore Ave., Baltimore, Md.
- Wilcox-Gay Corp., Charlotte, Mich.
- Zenith Radio Corp., 6001 Dickens Ave., Chicago, Ill.

Galvin Firm Honored

The Galvin Mfg. Corp., 4545 Augusta Blvd., Chicago, makers of Motorola radios, Handie-Talkies, Walkie-Talkies, and other radar-radio equipment for the armed forces, was one of the recipients of the Certificate of Achievement awarded to the Radar-Radio Industries of Chicago by the Navy Department.

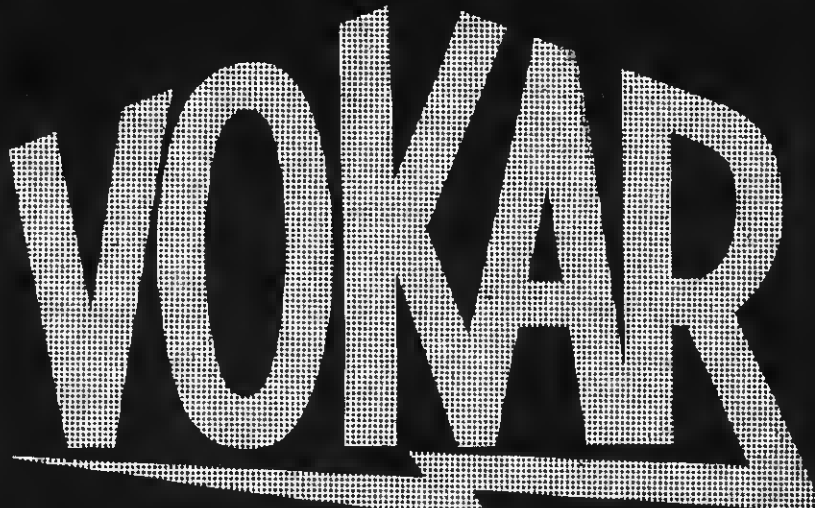

Manufacturers of
RADIO, ELECTRICAL AND
ELECTRONIC COMPONENTS

ELECTRONIC PRODUCTS MFG. CORP.
DEXTER, MICHIGAN



"IN GREECE A
"GRAMME"
IS .03937 OF AN INCH
 For certain types of measuring,
 this would appear to be accuracy
 in the Nth Degree.

But for the really precise and delicate calibrations required in the Radio and Electronics Fields, instruments that guarantee amazing precision must be brought into play. For many years,

MONARCH

MEASURING—TESTING—CALIBRATING EQUIPMENT has been considered outstanding in helping to produce and maintain the high standards of operation required for both war and peace.

When the requirements of war are satisfied to the degree that we can produce for peace ... we will be ready with new ideas and new products to meet every accumulated need.

MONARCH MFG. CO.
2014 N. Major Ave. Chicago, Ill.

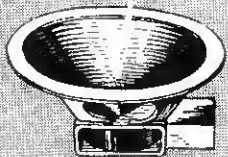
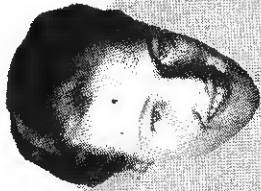

the excellence of your post-war radio engineering

will be faithfully interpreted for your customers by a **QUAM** Speaker

QUAM-NICHOLS CO. 33rd PLACE AT COTTAGE GROVE, CHICAGO

Centralized Sound System

(Continued from page 45)

speaker location-viz off, channel A-B, talk-back.

- (9) Provide switching facilities for control of two-way communication system between class room and control panel.

The control panel designed by Mr. Doyle for the job gives full control of the system. The basic layout of this panel provides an "input origination" selector switch for each input position of each amplifier channel (total of four switches). These selectors permit the operator to connect the radio, a microphone in the school auditorium, or other events originating at various parts of the building into the appropriate channel. Key switches control the speaker group in each room and enable the operator to connect them to either amplifier channel.

8" and 12" Speakers Used in Classrooms

Classrooms have 8-inch permanent field speakers with primary windings adjustable from 225 to 5000 ohms.

The Cafeteria and the General Utility rooms each have 12-inch speakers of the same type, with adjustable transformers. The General Utility room is in reality a small auditorium and has a small stage.

The main auditorium has two 12-inch dynamic speakers with directional baffles. These are mounted behind suitable grills.

In an installation of this type, it is important to get good quality from the intercommunication, as well as the programs sent over the system. The impedance of the lines should be as low as possible. The class room and the other 8-inch speakers were connected to the 1250-ohm taps on the speaker transformers. This system has been in operation since early 1941 and outside of routine checking not one penny has been spent on maintenance.

Radio Pioneer

Architects for the Katonah High School were Starrett and Van Vleck.

R. J. Doyle is a pioneer in the radio field. He operates a large radio repair shop at Mt. Kisco, N. Y., also handles radios and appliances. He has made a large number of big sound installations including schools, state prisons, and other public buildings. Doyle specializes in sound moving picture installations, and is also active in television.

INDEX To Advertisers

	Page
Admiral Corp.	1
Aerovox Corp.	20
Alliance Mfg. Co.	106
Astatic Corp.	98
Atlas Sound Corp.	114
Automatic Radio Mfg. Co., Inc.	104
Bell Sound Systems, Inc.	92
Bogen Co., Inc., David	111
Burgess Battery Co.	107
Centralab	106
Clarostat Mfg. Co., Inc.	108
Cornish Wire Co., Inc.	118
Crosley Corp.	23
Delco Radio Div. General Motors	87
Detrola Radio Div. Internat'l Detrola Co.	55
Dumont Electric Co.	116
DuMont Laboratories, Inc., Allen B.	79
Duotone Co.	94
Electric Soldering Iron Co., Inc.	112
Electronic Corp. of America	105
Electronic Laboratories, Inc.	9
Electronic Products Mfg. Corp.	119
Electro Products Labs.	112
Electro-Voice Corp.	109
Emerson Radio & Phonograph Corp.	59
Fada Radio & Electric Co., Inc.	17
Farnsworth Television & Radio Corp.	7
Freed Radio Corp.	93
Galvin Mfg. Corp.	Cover 4
Garod Radio Corp.	15
General Electric Co.	97
General Industries Co.	117
Hallcrafters Co.	68
Hamilton Radio Corp.	53
Hammarlund Mfg. Co., Inc.	95
Hatry & Young	114
Hickok Electrical Instrument Co.	103
Howard Radio Co.	28
Hytron Corp.	26
International Resistance Co.	99
Jackson Electrical Instrument Co.	96
Jensen Radio Mfg. Co.	22
Ken-Rad Tube & Lamp Corp.	113
Lear, Inc.	56
Maguire Industries, Inc., Electronics Div.	19
Majestic Radio & Television Corp.	83
Mallory & Co., Inc., P. R.	Cover 2
Meck Industries, John	5
McGee Radio & Electric Co.	109
Merit Coil & Transformer Corp.	4
Monarch Mfg. Co.	119
Muter Co.	108
National Union Radio Corp.	75
Noblitt-Sparks Industries, Inc.	8
Norge Division, Borg-Warner Corp.	12, 13
Nu Enamel Corp.	27
Olson Radio Warehouse	118
Onan & Sons, D. W.	110
Operadio Mfg. Co.	118
Park Metalware Co., Inc.	117
Permo, Inc.	112
Philco Corp.	2, 3
Philharmonic Radio Corp.	25
Presto Recording Corp.	74
Quam-Nichols Co.	120
Radiart Corp.	112
Radio City Products	100
Radio Corp of America:	
R.C.A. Victor Division	61, 62, 63, 64
Radio Equipment Co.	118
Radio Merchandise Sales	101
Rauland Corp.	104
Ray-O-Vac Battery Co.	14
Raytheon Mfg. Co.	29
Rider Publisher, Inc., John F.	115
Rola Co., Inc.	24
Rothenstein, Albert	102
Seeburg Corp., J. P.	Cover 3
Sentinel Radio Corp.	11
Simpson Electric Co.	78
Snyder Mfg. Co.	117
Solar Mfg. Corp.	10
Sonora Radio & Television Corp.	72
Sprague Products Co.	16
Standard Transformer Corp.	107
Stewart-Warner Corp.	21
Stromberg-Carlson Co.	30
Supreme Instruments Corp.	116
Sylvania Electric Products Inc.	18
Templeton Radio Co.	81
Thordarson Electric Mfg. Co.	69
Trav-Ler Karenola Radio & Television Corp.	89
Triplet Electrical Instrument Co.	70
Tung-Sol Lamp Works, Inc.	6
Turner Co.	73
Universal Microphone Co.	52
Utah Radio Products Co.	57
Vaughan Cabinet Co.	110
Ward Leonard Electric Co.	84
Ward Products Corp.	85
Warwick Mfg. Corp.	77
Waters Conley Co.	71
Webster Electric Co.	102
Wilcox-Gay Corp.	51
Zenith Radio Corp.	91

"Judged by
the company
you keep"



● **LEADING PHONOGRAPH-RADIO COMBINATION
MANUFACTURERS HAVE USED
DEPENDABLE SEEBURG RECORD CHANGERS**

● **LEADING PHONOGRAPH-RADIO COMBINATION
MANUFACTURERS CAN DEPEND
UPON SEEBURG RECORD CHANGERS**

After Victory!

BUY WAR BONDS

Awarded to the J. P. Seeburg Corporation
for outstanding production of war
materials in each of its four plants



J. P. SEEBURG CORPORATION · CHICAGO

Seeburg

FINE MUSICAL INSTRUMENTS SINCE 1909

Extraordinary RECOGNITION

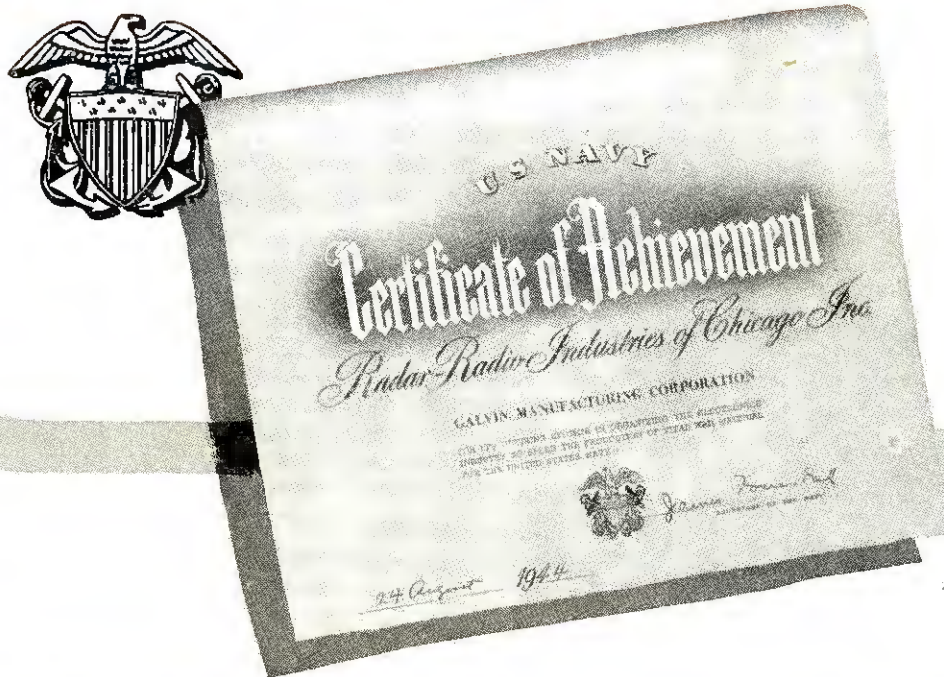

The United States Navy has created a special award of merit. This certificate of achievement was presented to the Radar-Radio Industries of Chicago in a colorful ceremony at Wrigley Field on Sunday, September 10th, for their extraordinary contribution to the successful

prosecution of the war. The Galvin Mfg. Corporation, manufacturers of Motorola F-M radio for home and car, is proud of its membership in the Radar-Radio Industries of Chicago . . . and also proud of the part it has been privileged to play in the winning of this signal honor.

Since considerably before Pearl Harbor, Motorola has designed, built and delivered military radio communications in great quantity among which are the famous "Handie Talkie" (an exclusive Motorola Radio First) and the equally celebrated F-M "Walkie Talkie." When victory has been won Motorola's greatly expanded production facilities will be available for the immediate production of Home and Car Radio, Portables and Automatic Phonographs.

BUY ANOTHER WAR BOND TODAY!

GALVIN MANUFACTURING CORPORATION, CHICAGO 51



Motorola Radio

F-M HOME & CAR RADIO • AUTOMATIC PHO

POLICE RADIO • RADAR • MILITARY RADIO COMMUNICATIONS